

WFM6100 / WFM7000 / WFM7100
Waveform Monitors
Quick Start User Manual

Copyright © Tektronix. All rights reserved. Licensed software products are owned by Tektronix or its subsidiaries or suppliers, and are protected by national copyright laws and international treaty provisions.

Tektronix products are covered by U.S. and foreign patents, issued and pending. Information in this publication supersedes that in all previously published material. Specifications and price change privileges reserved.

TEKTRONIX and TEK are registered trademarks of Tektronix, Inc.

Manufactured under license from Dolby Laboratories. *Dolby*, *Pro Logic*, and the double-D symbol are trademarks of Dolby Laboratories.

Contacting Tektronix

Tektronix, Inc.
14200 SW Karl Braun Drive
P.O. Box 500
Beaverton, OR 97077
USA

For product information, sales, service, and technical support:

- In North America, call 1-800-833-9200.
- Worldwide, visit www.tektronix.com to find contacts in your area.

Warranty 2

Tektronix warrants that this product will be free from defects in materials and workmanship for a period of one (1) year from the date of shipment. If any such product proves defective during this warranty period, Tektronix, at its option, either will repair the defective product without charge for parts and labor, or will provide a replacement in exchange for the defective product. Parts, modules and replacement products used by Tektronix for warranty work may be new or reconditioned to like new performance. All replaced parts, modules and products become the property of Tektronix.

In order to obtain service under this warranty, Customer must notify Tektronix of the defect before the expiration of the warranty period and make suitable arrangements for the performance of service. Customer shall be responsible for packaging and shipping the defective product to the service center designated by Tektronix, with shipping charges prepaid. Tektronix shall pay for the return of the product to Customer if the shipment is to a location within the country in which the Tektronix service center is located. Customer shall be responsible for paying all shipping charges, duties, taxes, and any other charges for products returned to any other locations.

This warranty shall not apply to any defect, failure or damage caused by improper use or improper or inadequate maintenance and care. Tektronix shall not be obligated to furnish service under this warranty a) to repair damage resulting from attempts by personnel other than Tektronix representatives to install, repair or service the product; b) to repair damage resulting from improper use or connection to incompatible equipment; c) to repair any damage or malfunction caused by the use of non-Tektronix supplies; or d) to service a product that has been modified or integrated with other products when the effect of such modification or integration increases the time or difficulty of servicing the product.

THIS WARRANTY IS GIVEN BY TEKTRONIX WITH RESPECT TO THE PRODUCT IN LIEU OF ANY OTHER WARRANTIES, EXPRESS OR IMPLIED. TEKTRONIX AND ITS VENDORS DISCLAIM ANY IMPLIED WARRANTIES OF MERCHANTABILITY OR FITNESS FOR A PARTICULAR PURPOSE. TEKTRONIX' RESPONSIBILITY TO REPAIR OR REPLACE DEFECTIVE PRODUCTS IS THE SOLE AND EXCLUSIVE REMEDY PROVIDED TO THE CUSTOMER FOR BREACH OF THIS WARRANTY. TEKTRONIX AND ITS VENDORS WILL NOT BE LIABLE FOR ANY INDIRECT, SPECIAL, INCIDENTAL, OR CONSEQUENTIAL DAMAGES IRRESPECTIVE OF WHETHER TEKTRONIX OR THE VENDOR HAS ADVANCE NOTICE OF THE POSSIBILITY OF SUCH DAMAGES.

Table of Contents

General Safety Summary	iii
Environmental Considerations	v
Preface	vi
Key Features	vi
Documentation	viii
Conventions Used in this Manual	viii
Before Installation	1
Check Package Contents	1
Standard Accessories	1
Optional Accessories	1
Options	2
Installation	4
Connecting Power and Powering On/Off	4
Installing the Monitor in a Video System	4
How to Operate Your Instrument	7
Overview	7
Front Panel Controls and Connectors	11
Elements of the Display	13
Rear-Panel Connectors	16
To Select a Measurement	25
To Set Display and Measurement Parameters	26
To Select Among Video Inputs	26
To Set Gain, Horizontal Magnification and Sweep	28
To Use Presets	30
To Measure Waveforms with Cursors	39
To Capture the Display	40
To Set Line Select Mode	46
To Adjust Headphone Volume and Source	47
To Configure Your Instrument	48
To Use Online Help	49
To Connect to a Network	51
To Connect Directly to a PC	54
To Print Screens and Event Logs	54
To Create a User Menu	58
Waveform Display	61
Vector Display	63
Picture Display	64
Audio Display	65
Lightning Display	69
Diamond Display	70
Arrowhead Display	71
Timing Display	72

Bowtie Display	75
DataList Status Display	76
ANC Data Display	77
Status Displays	78
Eye Display	82
Jitter Display	84
SDI Status Display	85
Monitoring the SDI Physical Layer	86
To Configure the Physical Layer Settings	86
To Take Eye Measurements	92
Timing a Studio	97
Using the Timing-Display Method	97
Timing Multiple Inputs to a Router	99
Checking Chroma/Luma Delay (Lightning Display)	102
Checking Gamut	105
Setting up for Gamut Checks	105
Checking RGB Gamut	107
Checking Composite Gamut	109
Checking Luma Gamut	110
Automating Gamut Checks	111
Adjusting Gamut Limits	112
Selecting and Monitoring Audio	114
Selecting the Audio Input	114
Checking Audio Level & Phase	116
Checking Surround Sound	118
Remote Communications	124
Using the Remote Web Interface	124
Using the Remote Application	125
To Upgrade the Waveform Monitor Software	127
PC System Requirements	127
Before You Begin	127
Installing the Software	128
Verifying the Upgrade	130
Specifications	133
Index	

General Safety Summary

Review the following safety precautions to avoid injury and prevent damage to this product or any products connected to it.

To avoid potential hazards, use this product only as specified.

Only qualified personnel should perform service procedures.

While using this product, you may need to access other parts of a larger system. Read the safety sections of the other component manuals for warnings and cautions related to operating the system.

To Avoid Fire or Personal Injury

Use Proper Power Cord. Use only the power cord specified for this product and certified for the country of use.

Connect and Disconnect Properly. Do not connect or disconnect probes or test leads while they are connected to a voltage source.

Connect and Disconnect Properly. De-energize the circuit under test before connecting or disconnecting the current probe.

Connect and Disconnect Properly. Connect the probe output to the measurement instrument before connecting the probe to the circuit under test. Connect the probe reference lead to the circuit under test before connecting the probe input. Disconnect the probe input and the probe reference lead from the circuit under test before disconnecting the probe from the measurement instrument.

Ground the Product. This product is grounded through the grounding conductor of the power cord. To avoid electric shock, the grounding conductor must be connected to earth ground. Before making connections to the input or output terminals of the product, ensure that the product is properly grounded.

Ground the Product. This product is indirectly grounded through the grounding conductor of the mainframe power cord. To avoid electric shock, the grounding conductor must be connected to earth ground. Before making connections to the input or output terminals of the product, ensure that the product is properly grounded.

Observe All Terminal Ratings. To avoid fire or shock hazard, observe all ratings and markings on the product. Consult the product manual for further ratings information before making connections to the product.

Connect the probe reference lead to earth ground only.

Do not apply a potential to any terminal, including the common terminal, that exceeds the maximum rating of that terminal.

Power Disconnect. The power cord disconnects the product from the power source. Do not block the power cord; it must remain accessible to the user at all times.

Do Not Operate Without Covers. Do not operate this product with covers or panels removed.

Do Not Operate With Suspected Failures. If you suspect that there is damage to this product, have it inspected by qualified service personnel.

Avoid Exposed Circuitry. Do not touch exposed connections and components when power is present.

Do Not Operate in Wet/Damp Conditions.

Do Not Operate in an Explosive Atmosphere.

Keep Product Surfaces Clean and Dry.

Provide Proper Ventilation. Refer to the manual's installation instructions for details on installing the product so it has proper ventilation.

Terms in this Manual

These terms may appear in this manual:



WARNING. *Warning statements identify conditions or practices that could result in injury or loss of life.*



CAUTION. *Caution statements identify conditions or practices that could result in damage to this product or other property.*

Symbols and Terms on the Product

These terms may appear on the product:

- DANGER indicates an injury hazard immediately accessible as you read the marking.
- WARNING indicates an injury hazard not immediately accessible as you read the marking.
- CAUTION indicates a hazard to property including the product.

The following symbols may appear on the product:



CAUTION
Refer to Manual



Protective Ground
(Earth) Terminal

Environmental Considerations

This section provides information about the environmental impact of the product.

Product End-of-Life Handling

Observe the following guidelines when recycling an instrument or component:

Equipment Recycling. Production of this equipment required the extraction and use of natural resources. The equipment may contain substances that could be harmful to the environment or human health if improperly handled at the product's end of life. In order to avoid release of such substances into the environment and to reduce the use of natural resources, we encourage you to recycle this product in an appropriate system that will ensure that most of the materials are reused or recycled appropriately.

The symbol shown below indicates that this product complies with the European Union's requirements according to Directive 2002/96/EC on waste electrical and electronic equipment (WEEE). For information about recycling options, check the Support/Service section of the Tektronix Web site (www.tektronix.com).



Mercury Notification. This product uses an LCD backlight lamp that contains mercury. Disposal may be regulated due to environmental considerations. Please contact your local authorities or, within the United States, the Electronics Industries Alliance (www.eiae.org) for disposal or recycling information.

Restriction of Hazardous Substances

This product has been classified as Monitoring and Control equipment, and is outside the scope of the 2002/95/EC RoHS Directive. This product is known to contain lead, cadmium, mercury, and hexavalent chromium.

Preface

The WFM6100, WFM7000, & WFM7100 Waveform Monitors offer the monitoring capabilities needed in the production, post-production, distribution, and transmission of video content in either high-definition (HD) digital formats, standard-definition (SD) digital formats, or composite analog formats. With the installation of available measurement options, the WFM7100 and WFM6100 waveform monitor offers measurement capabilities important in the design, installation, and maintenance of digital video systems, including Eye diagrams with automated measurements, jitter, and data measurements. With available audio monitoring options, you can expand the capabilities of any model to monitor both digital and analog audio content. The WFM7100 and WFM7100 also have options for monitoring Dolby audio formats.

These products combine the best of traditional waveform monitors with the measurement accuracy, repeatability, and stability achievable with fully digital technology. The products that make up the WFM6100, WFM7000, & WFM7100 family are:

Model	Description	Features
WFM7100	HD and SD-capable with high-performance monitoring and measurement capabilities	<ul style="list-style-type: none"> ■ A high-resolution XGA display with the FlexVu™ interface and high-quality waveform processing. ■ CaptureVu™ capability that can capture a full frame of video data, either user-initiated or triggered by an alarm condition. ■ MyMenu capability that lets you create custom menus that simplify instrument operation. ■ Available measurement options that offer industry-leading capability for SDI signal measurement and video data analysis. ■ Available audio options that offer industry-leading audio monitoring capability, especially for Dolby audio formats. ■ Available composite video option that offers analog monitoring capability. ■ A wide range of options and upgrades that let user create instrument configurations best suited to their current needs with the ability to add features later as their needs change.
WFM7000	HD and SD-capable with basic monitoring capabilities	All the key features of the WFM7100 except CaptureVu, measurement options, and Dolby audio support.
WFM6100	SD-capable with high-performance monitoring and measurement capabilities	All the key features of the WFM7100 except support for HD digital video.

Key Features

The key features for all models include:



- High-resolution XGA display with the FlexVu™ interface and high-quality waveform processing, providing outstanding picture and signal displays and exceptional flexibility in creating multi-view displays.

- Extensive fault detection, alarm generation, error logging and status reporting, including quality statistics on both video and audio content.
- Up to four independent picture displays of the monitored input that can show different safe area graticules and decoded closed caption services.
- Proprietary Split Diamond and Arrowhead displays that help quickly detect and correct gamut problems.
- Sophisticated audio level and phase displays, including an exclusive display for surround sound audio, which helps reduce time and effort in creating and verifying audio content.
- A proprietary Timing display that graphically shows the timing relationship between the input signal and an external reference signal or a saved offset. This easy-to-interpret display, along with numeric readouts of vertical and horizontal timing relationships, reduces time and effort in verifying and correcting signal timing.
- User-defined menus (MyMenu) give easy access to frequently used operations and simplify instrument operations.
- Up to 20 instrument presets organized in four groups of five presets per group for easy access, with user-definable labels for quick identification.
- A front-panel USB 2.0 port for easily storing and recalling captured data and instrument presets.
- A convenient front-panel headphone port for quickly verifying sound quality. Simple touch screen controls let you quickly check the stereo pairs shown on the audio bar display.
- Network access and control through a simple, Web-page interface, a more complete Java-based remote control interface, or by SNMP. Ground-closure remote control port with an alarm output and support for recalling instrument presets.
- Support for printing the display and event log on USB printers.

WFM6100 and WFM7100 only:

- CaptureVu™ capability that can capture a full frame of video data and can compare live to captured data on the waveform, vector, gamut, and picture displays. Data can be captured using the touch-screen menu or triggered by up to 14 alarm conditions. Captured data can be stored on a USB flash drive for transfer to another instrument or to a PC for more in-depth analysis.
- Up to four independent displays of the signal characteristics of an SDI input, including Eye diagrams and measurements, jitter readouts and bar display, jitter waveform display, and SDI status screen.
- Two independent jitter measurements with separate high pass filters that offer simultaneous display of peak-to-peak amplitudes of timing and alignment jitter.
- Cable loss measurement with source level and cable length estimates based on user-specified cable type.
- Extensive support for monitoring Dolby audio content, including auto-sensing Dolby formats, decoding Dolby content and automatically configuring the appropriate audio level and phase displays, and showing decoded Dolby metadata.

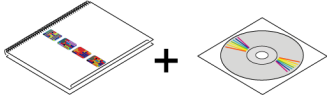
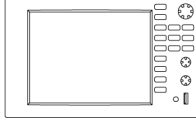
Documentation

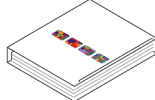
Item	Purpose	Location
<i>WFM6100, WFM7000, & WFM7100 Series Waveform Monitors Quick Start User Manual</i>	Installation and high-level operational overview. (This manual.)	
<i>WFM6100, WFM7000, & WFM7100 Series Online Help</i>	Context-sensitive operation and user interface help.	
<i>WFM6100, WFM7000, & WFM7100 Series Waveform Monitors Performance Verification and Specifications</i>	Procedure for checking performance and list of specifications.	 WWW.Tektronix.com
<i>WVR & WFM Series Programmer Manual</i>	Programmers command reference for controlling the instrument.	 WWW.Tektronix.com
<i>WFM6100, WFM7000, & WFM7100 Series Waveform Monitors Service Manual</i>	Optional manual supporting module-level servicing of the instrument.	

Conventions Used in this Manual

The following icons are used throughout this manual:

Sequence Step



Connect power

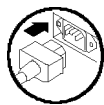

Network

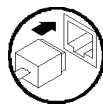

XGA

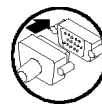

USB

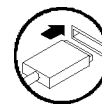

Before Installation

Check Package Contents

Unpack the instrument and check that you received all items listed as *Standard Accessories*. Check the Tektronix Web site (www.tektronix.com) for the most current information.

Standard Accessories

Documents

The following documents are standard accessories:

- *WFM6100, WFM7000 & WFM7100 Waveform Monitors Quick Start User Manual*, Tektronix part number 071-1890-XX.
- *WFM6100, WFM7000 & WFM7100 Waveform Monitors Release Notes*, Tektronix part number 071-1895-XX.
- *WFM6100, WFM7000 & WFM7100 Waveform Monitors Documents CD*, Tektronix part number 063-3922-XX.
- *WFM6100, WFM7000 & WFM7100 Waveform Monitors Specifications and Performance Verification Technical Reference*, Tektronix part number 071-1897-XX.

Power Cords

The WFM6100 / WFM7000 / WFM7100 Waveform Monitors are shipped with one of the following power cord options. Power cords for use in North America are UL listed and CSA certified. Cords for use in areas other than North America are approved by at least one authority acceptable in the country to which the product is shipped.

International Power Plugs

- Opt. A0 – North America power.
- Opt. A1 – Universal EURO power.
- Opt. A2 – United Kingdom power.
- Opt. A3 – Australia power.
- Opt. A4 – 240 V, North America power.
- Opt. A5 – Switzerland power.
- Opt. A6 – Japan power.
- Opt. A10 – China power.
- Opt. A99 – No power cord or AC adapter.

Optional Accessories

- *WFM7F02*, Portable cabinet with handle, feet, tilt bail and front panel cover.

- *WFM7F05*, Dual rackmount for *WFM6100*, *WFM7000*, *WFM7100*, 1700 Series, *WFM601 Series*, *WFM700 Series*, 760A, and 764. Each half of the rack can be ordered as either Option O or Option N. Option N is used for *WFM700*, *WFM6100*, *WFM7000*, and *WFM7100* monitors. Option O is used for 1700 Series, *WFM601 Series*, 760A and 764 instruments.
- *WFM6100 / WFM7000 / WFM7100 Waveform Monitors Service Manual*, Tektronix part number 071-0915-XX.

Options

A number of hardware options are available for the *WFM6100*, *WFM7000* & *WFM7100* Waveform Monitors. The following table lists the options that are available when ordering an instrument and specifies the models for which the option can be ordered.

WFM7100

Video Options	Description
<i>CPS</i>	Adds support for Composite Analog Monitoring; 2 Composite Analog Inputs.
<i>SD</i>	Adds support for Standard Definition Monitoring; 2 SD SDI Inputs.
<i>HD</i>	Adds support for High Definition inputs; 2 HD SDI Inputs.
Audio Options	Description
<i>DS</i>	Adds support for Digital Audio Monitoring in embedded and AES/EBU formats
<i>AD</i>	Adds support for Analog Audio monitoring and Digital Audio monitoring (embedded and AES/EBU inputs).
<i>DD</i>	Adds support for Dolby Digital (AC-3) decode, Digital Audio (embedded and AES/EBU inputs) and for Analog Audio Monitoring.
<i>DDE</i>	Adds support for Dolby E decode, Dolby Digital (AC-3) decode, Digital Audio (embedded and AES/EBU inputs) and for Analog Audio Monitoring. Supports digital audio formats with up to eight channels.
Eye/Jitter and Data Analysis Options	Description
<i>EYE</i>	Adds eye pattern and basic jitter measurement. The Eye option enables the display of Eye Patterns in 3-Eye, 10-Eye (SD), or 20-Eye (HD) modes, cable length measurements (including source signal level and cable loss), and Jitter readout.
<i>PHY</i>	Includes the capabilities of Eye option plus advanced physical layer measurements; jitter waveform, and automated eye measurements.
<i>DAT</i>	Adds data analysis capabilities. Allows for logic-level view of video and audio digital data stream and ANC data extraction.

WFM7000

Video Options	Description
<i>CPS</i>	Adds support for Composite Analog Monitoring; 2 Composite Analog Inputs.
<i>SD</i>	Adds support for Standard Definition Monitoring; 2 SD SDI Inputs.
<i>HD</i>	Adds support for High Definition inputs; 2 HD SDI Inputs.
Audio Options	Description

Video Options	Description
<i>DS</i>	Adds support for Digital Audio Monitoring in embedded and AES/EBU formats.
<i>AD</i>	Adds support for Analog Audio monitoring and Digital Audio monitoring (embedded and AES/EBU inputs).

WFM6100

Video Options	Description
<i>CPS</i>	Adds support for Composite Analog Monitoring; 2 Composite Analog Inputs.
<i>SD</i>	Adds support for Standard Definition Monitoring; 2 SD SDI Inputs.
Audio Options	Description
<i>DS</i>	Adds support for Digital Audio Monitoring in embedded and AES/EBU formats.
<i>AD</i>	Adds support for Analog Audio monitoring and Digital Audio monitoring (embedded and AES/EBU inputs).
<i>DD</i>	Adds support for Dolby Digital (AC-3) decode, Digital Audio (embedded and AES/EBU inputs) and for Analog Audio Monitoring.
<i>DDE</i>	Adds support for Dolby E decode, Dolby Digital (AC-3) decode, Digital Audio (embedded and AES/EBU inputs) and for Analog Audio Monitoring. Supports digital audio formats with up to eight channels.
Eye/Jitter and Data Analysis Options	Description
<i>EYE</i>	Adds eye pattern and basic jitter measurement. The Eye option enables the display of Eye Patterns in 3-Eye, 10-Eye (SD), or 20-Eye (HD) modes, cable length measurements (including source signal level and cable loss) and Jitter readout.
<i>PHY</i>	Includes the capabilities of Eye option plus advanced physical layer measurements; jitter waveform, and automated eye measurements.
<i>DAT</i>	Adds data analysis capabilities. Allows for logic-level view of video and audio digital data stream and ANC data extraction.

There are three post-sale upgrade kits available for installation in WFM6100, WFM7000, and WFM7100 Waveform Monitors that you already own. Some options are customer installable and others can be installed only at a Tektronix Service Facility. The following table lists the options that are available when ordering an instrument and specifies the models for which the option can be ordered.

Option	Description
<i>WFM61UP</i>	Upgrade kit for WFM6100. Upgrade by ordering WFM61UP with appropriate options: CPS, SD, DS, AD, DD, DDE, EYE, PHY, DAT.
<i>WFM70UP</i>	Upgrade kit for WFM7000. Upgrade by ordering WFM70UP with appropriate options: CPS, SD, HD, DS, AD.
<i>WFM71UP</i>	Upgrade kit for WFM7100. Upgrade by ordering WFM71UP with appropriate options: CPS, SD, HD, DS, AD, DD, DDE, EYE, PHY, DAT.

Installation

The waveform monitor is shipped in a wrap-around chassis that covers the instrument bottom and two sides. A cover is installed on the chassis, and the rear panel is made up of the module rear panels. You can operate the waveform monitor in the instrument chassis (be sure the top cover is on) or installed in an approved portable cabinet or rack adapter. You can also install the waveform monitor in a custom installation, such as a console.

To install the waveform monitor in a cabinet or rack, follow the instructions that are included with the optional accessory kits that are available for each type of installation.



CAUTION. *Do not install the waveform monitor in any cabinet except those that are listed in Optional Accessories. Attempting to do so can damage the waveform monitor and the cabinet.*

If you install the waveform monitor in a custom application, such as a console, be sure to provide adequate airflow. Do not block the ventilating holes.



CAUTION. *Failure to provide adequate airflow to the waveform monitor could cause the instrument to shut down. If the airflow is blocked and the instrument does not shut down, the instrument could be seriously damaged.*

Connecting Power and Powering On/Off

The waveform monitor operates from a single-phase power source with the neutral conductor at or near earth ground. The line conductor is fused for over-current protection. A protective ground connection through the grounding conductor in the power cord is essential for safe operation.

AC Power Requirements

The waveform monitor operates from an AC line frequency of 50 or 60 Hz, over the range of 100-240 Volts, without the need for configuration, except the power cord. (See page 1, *Power Cords*.)

The typical power draw is 50 Watts for a base unit. Refer to the *Specifications and Performance Verification* document for additional information on power and environmental requirements.

Connect the supplied power cord to the rear-panel power connector. There is no power switch on the waveform monitor, so the instrument will turn on as soon as you apply power.

Installing the Monitor in a Video System

The waveform monitor can operate almost anywhere in the distribution system. The following diagrams for serial digital systems and for the analog composite inputs.

To install for monitoring the video bit stream of a serial receiver:

1. Route the incoming serial signal into one of the waveform monitor SDI inputs.

NOTE. See the Specifications on the Documents CD for maximum allowed cable lengths.

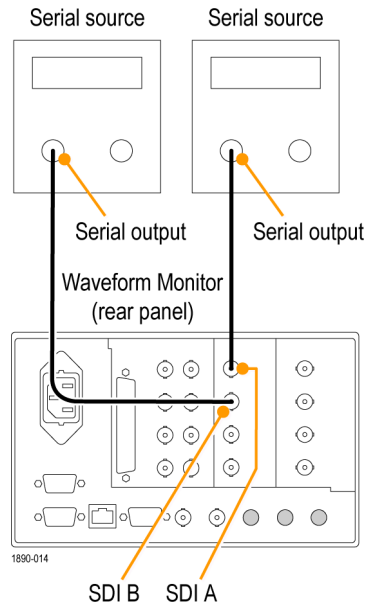

Option Eye/Phy

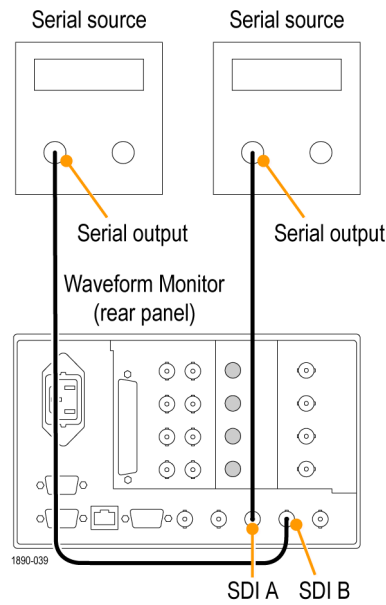

Option SD/HD

To install for monitoring composite signals:

1. Connect your sources to the CMPST A or CMPST B loop-through inputs on the rear panel.

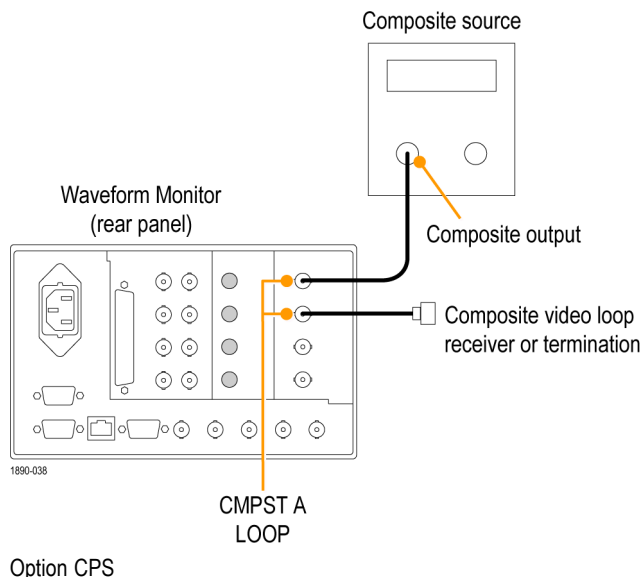

Line Termination

The waveform monitor uses passive loop-through analog and reference inputs. Accordingly, the loop-through inputs must be terminated externally. It is important that this external termination meet accuracy and return loss requirements.

If the waveform monitor is installed to monitor an operating link, the destination receiver and the connecting cable serve as the termination. This monitoring connection is best because it checks the performance of the entire path. The return loss of the waveform monitor is sufficiently high that, in most cases, the destination receiver sets the system return loss.

In cases where the waveform monitor is placed at the end of a link, a BNC termination must be installed on one side of the loop-through analog or reference connector. The termination must be 75 Ω and DC coupled (good return loss extends to DC). An appropriate termination would be Tektronix part number 011-0102-00. It is a 75 Ω , End of Line termination.

Compatibility of BNC Center Pins

Most video equipment BNC connectors, whether 50 or 75 Ω , use a 50 Ω standard center pin. Some laboratory 75 Ω BNC connectors use a smaller diameter center pin. The BNC connectors on the waveform monitor are designed to work with the 50 Ω standard (large diameter) center pins.

Do not use connectors or terminators with the smaller center pins. They could cause intermittent connections.

How to Operate Your Instrument

Overview

The waveform monitor uses a flexible, tiled display. The waveform monitor can display four tiles at one time. Each tile can display a different measurement, effectively creating four independent instruments. To enable the tiles to function independently, most of the controls affect only one tile at a time. The tile that is currently being controlled is considered the active tile and it is indicated on the display by a light-blue outline around the tile.

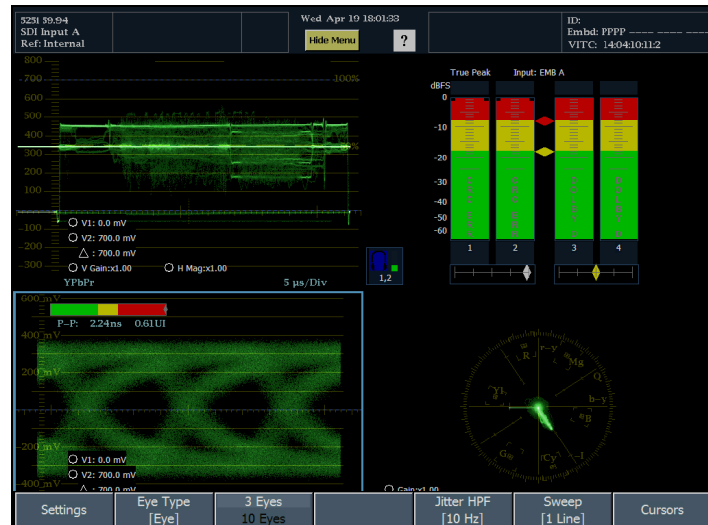

The waveform monitor can also display one tile at a time. For example, you might want to display just an Eye diagram to view the rise time measurement. To select a display to be shown in full-screen mode, press the DISPLAY button and select the icon that represents the tile you want displayed in full-screen mode.

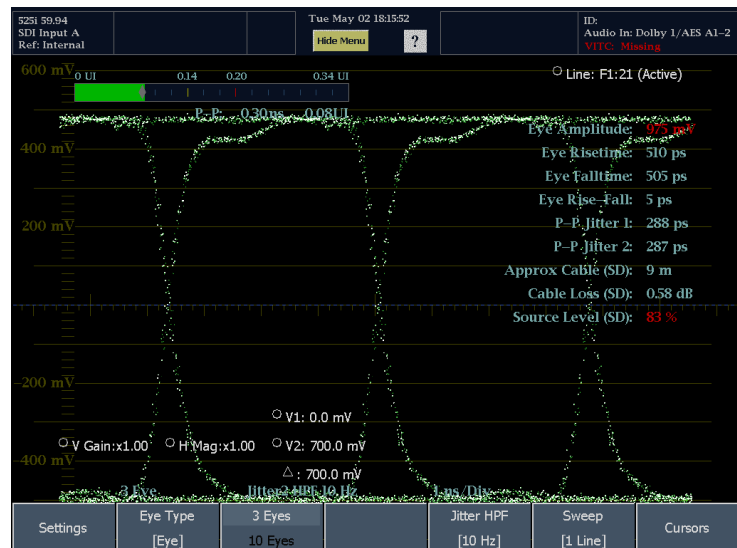

The waveform monitor can display measurements in multiple tiles simultaneously. For example, you can display four Status screens at one time. Two displays that cannot appear in more than one tile at a time are the Audio and DataList displays. They can be displayed in only one tile at a time.

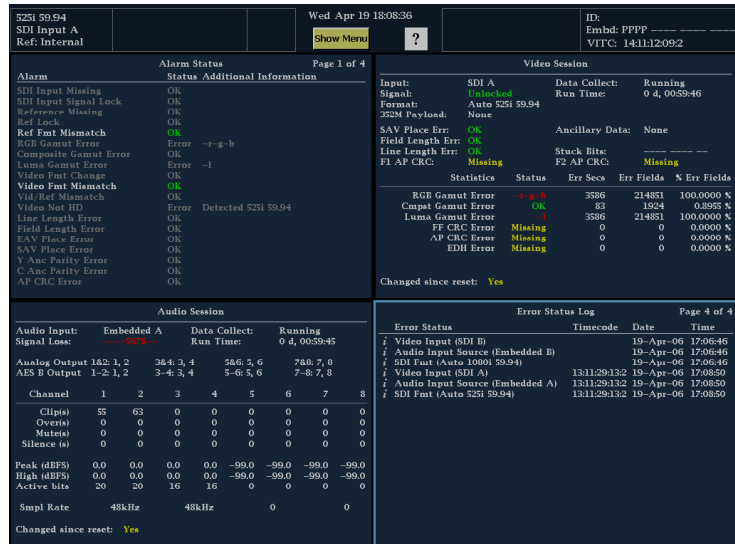

You can display four waveform displays at the same time with each waveform display configured differently.



Controlling the Waveform Monitor

There are three ways to control the waveform monitor. You can use the buttons on the front panel, you can use the touchable settings on the display, and you can use the menus that appear on the display (including the Main pop-up menu).

Use the front panel buttons to select frequently used displays, to select modes (LINE SEL) that affect multiple displays, change values using the large knob, or change the horizontal and vertical position of a waveform.

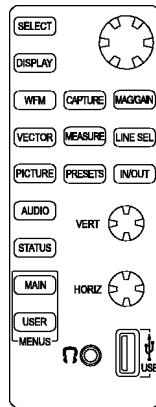

1890-040

Many values can be set from the display by selecting a touchable readout in the display. For example, you can change the position of a cursor by touching the cursor readout and changing its position using the large knob.

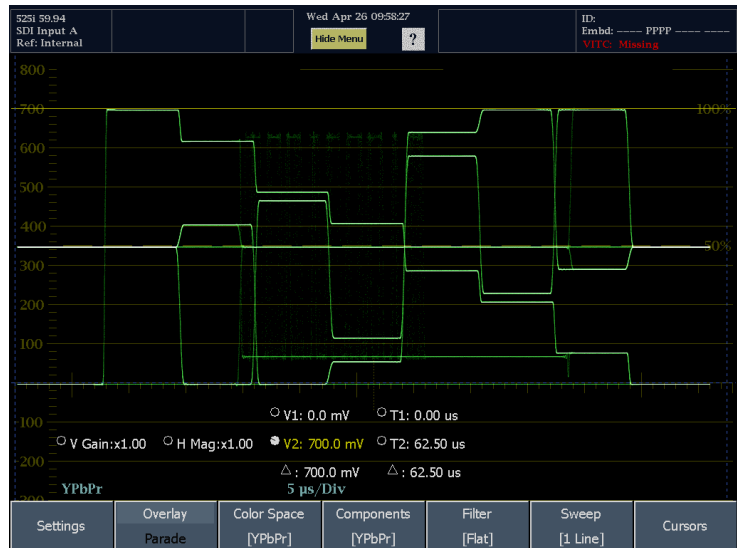

Virtually every display has its own menu. The display menu is used to change selections or set values for parameters that apply to the display. Many menus have multiple levels.

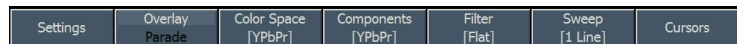

All displays are accessible from the Main pop-up menu. Some displays are available only from the Main pop-up menu. The Main menu (at the bottom of the display) is used to gain access to functions not tied to a specific display, such as printing or network settings. To display the Main pop-up menu, press MAIN and then touch any soft key in the pop-up menu to activate the desired display.

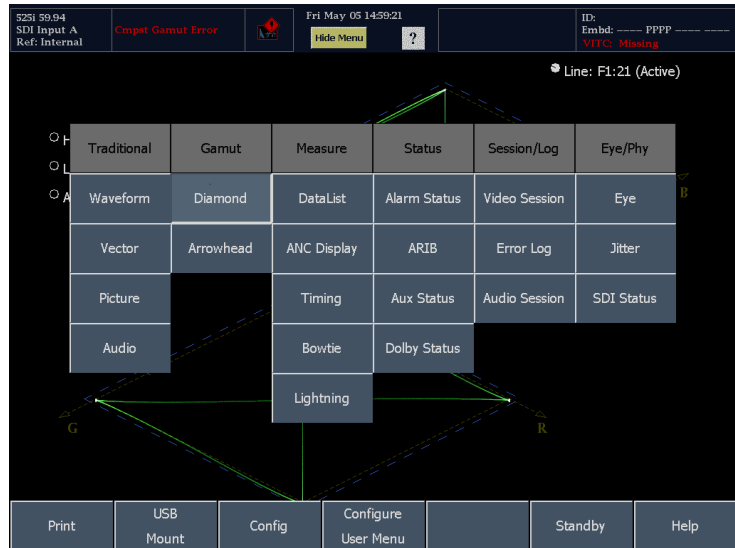

Tile Settings

Each tile maintains its own settings independent of the other tiles, such as GAIN, SWEEP, and display type. For instance, when you switch a tile to a different display, the GAIN and SWEEP settings will be changed to what they were the last time the selected display was shown in the tile. Display type is also independent for each tile.

NOTE. Only one tile can contain an Audio display or DataList display, and only one tile can have the Line Select mode enabled.

Perform the following steps to configure the display:

View All Available Measurements Using the Main Menu

Press the front-panel MAIN button to open the Main menu and display a pop-up menu showing all available measurements. Note that this pop-up menu is the only place you can access some measurements, such as SDI Status.

You can use the Main menu to perform the following tasks:

- Selecting one of the available display modes to view in the active tile.
- Printing the Error Log or the on-screen display.
- Configuring instrument settings.
- Configuring the custom User menu.
- Accessing the Shutdown and Quiet modes from the Standby menu.
- Mount and unmount USB flash drives.
- Display the Main Help page.

Front Panel Controls and Connectors

The waveform monitor can display either one or four views (tiles) at a time. Each view can display a different measurement or display type, effectively creating four independent instruments. To enable the tiles to function independently, most of the controls only affect one tile at a time.

FlexVu — Configuring the Display

The FlexVu feature allows you to view either one or four different displays (tiles) of the currently selected input signal. Listed below are two examples of using the four-tile display mode to monitor signals:

1. To switch between 4-Views and 1-View display mode, press the **DISPLAY** button.

This displays the Views menu at the bottom of the screen. Each tile is represented by a icon soft key in the menu.

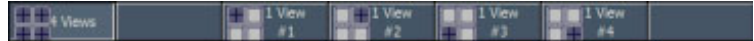

2. To display a tile full screen, touch the icon that represents the tile you want displayed in full screen mode.

In a full display, the displayed tile is always selected.

3. To return to four-tile view, press the Display button and select the 4-Views icon.

NOTE. Only one tile can contain an Audio display or DataList display, and only one tile can have the Line Select mode enabled. If you try to open a second Audio or DataList display, a pop-up message will appear informing you that a second display cannot be opened and the active tile will shift to the existing display.

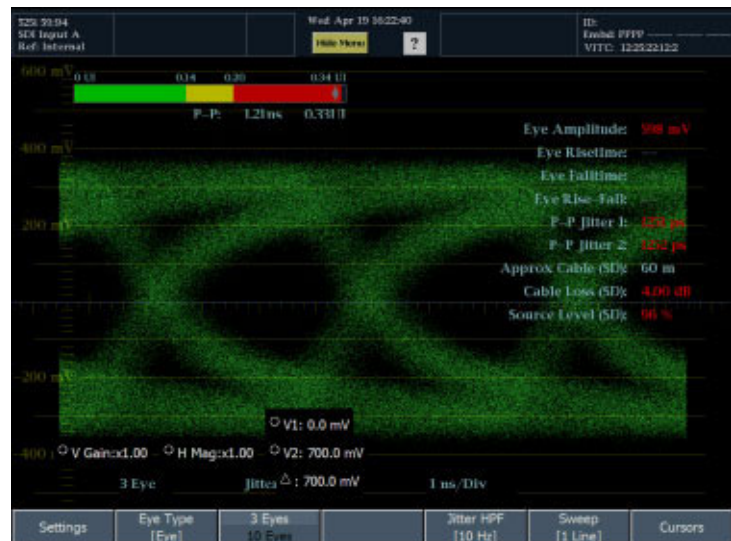

Front Panel Controls

The waveform monitor uses a touch-panel display, front-panel knobs and buttons to control the waveform monitor.

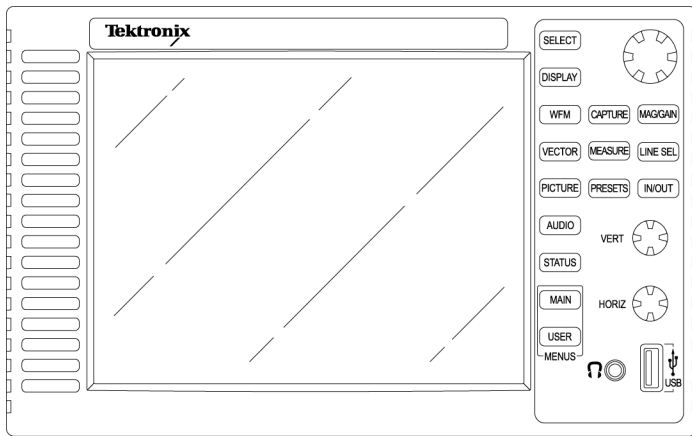

1890-001

Button	Function
SELECT	Toggles the selection between two or more items, sequences the selected item through a group of items. The SELECT button is lit when it is available for use.
DISPLAY	Displays the Views menu allowing you to change the display between one and four-tile view and select which tile is displayed in full-screen mode.
WFM	Changes the selected tile to display the input signal as a waveform.
VECTOR	Changes the selected tile to display the input signal on a vectorscope screen.
PICTURE	Changes the selected tile to display the input signal as a picture.
AUDIO	Changes the selected tile to display the Audio level and status screen.
STATUS	Displays the last Status display shown in the active tile and displays a menu allowing you to change the selected tile to display a status screen, a session display, or the error log.
MAIN	Displays the Main menu and Main pop-up menu, providing access to primary and secondary menus. Some displays are selectable only in the pop-up menu.
USER	Displays a user-defined menu.
CAPTURE	Displays menu that enables screen capture of live display.
MEASURE	Displays the last Measure display shown in the active tile and displays a menu allowing display and configuration of the Eye, Jitter, DataList, ANC Display, Timing, Bowtie, and Lightning displays.
PRESETS	Displays menu enabling save and recall of instrument settings.
MAG/GAIN	Displays the Mag/Gain menu with controls for the Vertical Magnification and Horizontal Gain.
LINE SEL	Enables/disables Line Select mode, displays Line Select menu if Line Select is enabled, but the Line Select menu is not visible.

IN/OUT	Displays a menu for configuring inputs and outputs.
Large Knob	Used to select or adjust values, for example, the cursor position.
VERT knob	Used to adjust the vertical position of the signal in the display.
HORIZ knob	Used to adjust the horizontal position of the signal in the display.

Front Panel Connectors

Connector	Function
Headphone jack	For listening to audio.
USB port	For attaching peripherals such as a printer or USB Flash Drive. The USB port is USB 1.1 and 2.0 compliant, full speed 12 Mb/s rate.

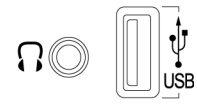

1890-013

Elements of the Display

Areas of the Display

Three major areas make up the display. They are the Status Bar area, the Main Display area, and the Menu area. The Main Display area is where the waveform monitor displays measurement results, signal traces, and status information. The Status Bar appears at the top of the display. The Status Bar provides a number of text and icon elements to give you an easily viewed guide to the status of the instrument and the monitored signal. The Menu area is where the waveform monitor displays menus. The menus provide access to settings that select measurement displays, measurement settings, instrument configuration parameters and more.

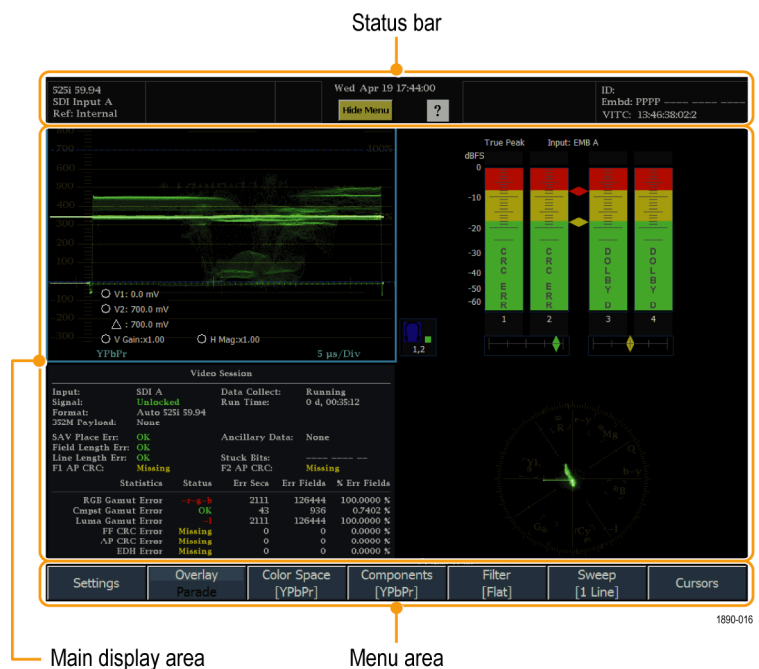

Making Selections from a Menu

A menu consist of a group of soft keys. There are several ways to respond to soft keys. How you make a selection depends on the type and number of choices available for the soft key. The types of menu keys are: command, toggle, option, knob-value, popup option and check-box soft keys.

Command Soft Keys: perform an action, such as invoking another menu.

For example, in most menus you select the Settings soft key to display a submenu of parameters that set for the displays.

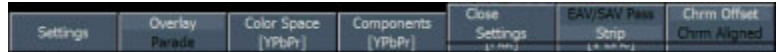

Toggle Soft Keys select between two or more values.

For example, in the Waveform menu there is a soft key that you use to specify whether the waveform is displayed in Overlay or Parade mode.

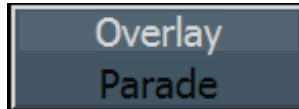

Option Soft Keys select a single item from a related group of choices.

For example, in the Mag Gain menu, Option menu keys are used to select the amount of vertical gain.



Knob-value Menu Keys connect the value to the knob, enabling the value to be changed by turning the knob.

For example, in the Closed Caption submenu, you can specify the line used for Closed Captioning by selecting the VBI CC Line soft key and turning the knob. Note that when the soft key is connected to the knob, the knob icon is filled in. You can disconnect the soft key from the knob by touching the soft key again.

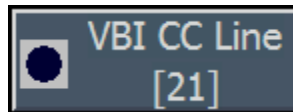

Check-box Menu Keys select between two settings, normally On/Off or Enabled/Disabled.

For example, in the Waveform Components menu, you can select the components that appear in the display. You can select all components to be displayed or only one component.



To Determine Input Signal Status At A Glance

The status bar shows the status of the instrument and of the monitored signal. The status bar appears in almost every display. The elements of the status bar are detailed below:

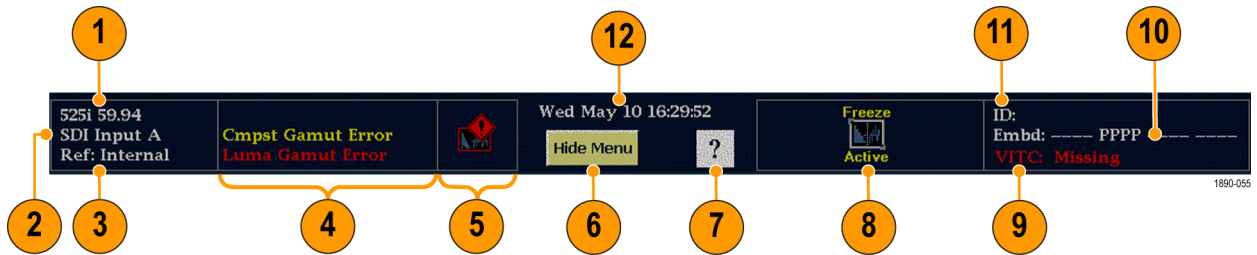

Element	Display element	Description
1	Video Format	Indicates the format of the signal on the selected video input or whether the signal is missing or unlocked.
2	Video Input	Text indicating the selected input. Possible inputs are: SDI A, SDI B, Cmpst Input A, Cmpst Input B (depending on model and installed options). Indicates if the current input is not in Auto mode by displaying the format in yellow text.
3	Video Reference	Text indicating the source of the current reference. Also indicates format and whether the reference is missing or unlocked.
4	EDH/CRC Error	A one-line area that is visible if EDH errors are present (SD inputs) or CRC errors are present (HD).
	RGB Gamut Error	A one-line area that is visible if RGB Gamut errors are present.
	Composite Gamut Error	A one-line area that is visible if Composite Gamut (Arrowhead) errors are present.
	Luma Gamut Errors	A one-line area that is visible if Luma errors are present.
5	Alarm/Error Indicator	An icon that is visible when alarms of types other than those in the four readouts just listed occur.
6	Show Menu / Hide Menu	Touching this soft key causes the menu at the bottom of the display to appear or disappear.
7	Online Help Enable	Touching this icon enables/disables the context sensitive help mode. While enabled, the icon color changes to green, and touching any soft key displays help for that soft key.
8	Freeze Status	Freeze appears when a Capture Trace or Capture Buffer action has been performed.
9	Timecode readout	A readout showing the selected time format.
10	Audio Channel Status	A 16-character string indicating embedded audio channel status. Each character shows the status of a specific channel: - for not present and P for present.
11	ID	The instrument name; set in MAIN > Config > Utilities > Communications > Instrument Name.
12	Date and Time	Readout of the date and time (set in MAIN > Config > Utilities > Set Clock).

Rear-Panel Connectors

The following figures shows the waveform rear panel with optional connectors. An instrument without the Eye or Phy options has the SDI inputs located along the bottom-right portion of the rear panel. An instrument with an Eye or Phy option has the SDI inputs arranged vertically.

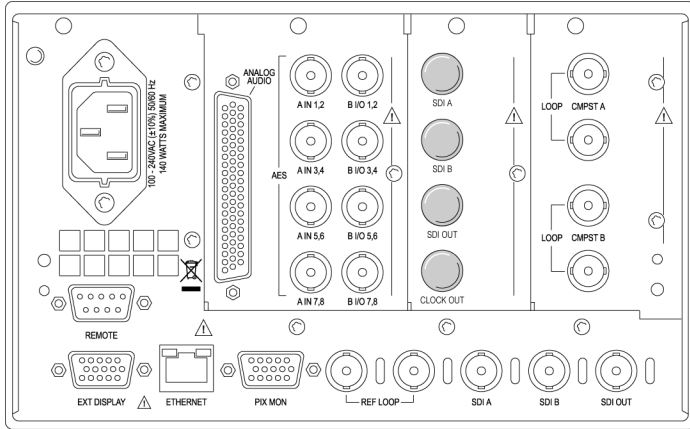

1890-042

Options SD/HD

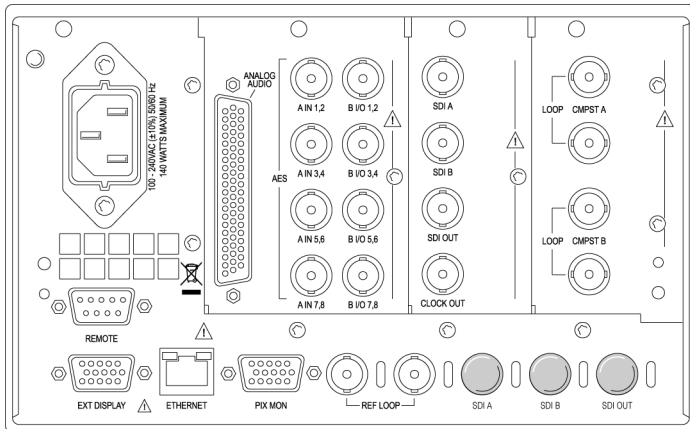

1890-041

Options Eye/Phy

Power Requirements

- A single-phase power source with one current-carrying conductor at or near earth-ground (the neutral conductor).
- The power source frequency must be 50 or 60 Hz, and a operating voltage range must be from 100 to 240 VAC, continuous.
- Systems with both current-carrying conductors live with respect to ground (such as phase-to-phase in multiphase systems) are not recommended as power sources.

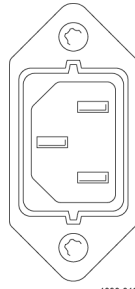

1890-012

NOTE. Only the line conductor is fused for over-current protection. The fuse is internal.

Video Input Connectors

SDI inputs are active inputs. Reference and Composite inputs are passive inputs, compensated for 75 Ω .

1. **Ref Loop.** A synchronization input. The input signal can be analog black burst, analog composite video, or analog tri-level for HD.

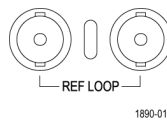

1890-010

- 2. **SDI A.** The Digital A component serial digital input.
- 3. **SDI B.** The Digital B component serial digital input.
- 4. **SDI Out.** Digital version of RGB/YPbPr analog pix monitor output. Gamut and or line select bright-ups optionally displayable. Can also be selected to be a loop-through of the active SDI input.
- 5. **Clock Out** Recovered clock output. Options Eye/Phy only.



SDI A



SDI B



SDI OUT



CLOCK OUT

1890-008

Option Eye/Phy



SDI A

SDI B

SDI OUT

1890-011

Option SD/HD

CMPST A and CMPST B composite inputs.

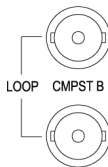
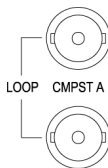

1890-009

Option CPS

Supported Reference Signals

The following tables indicate the supported combinations of input format and reference format. An “X” indicates a tested combination. Other combinations of input signal and reference signal within each table may work, but are not warranted. Operation with an input from one table and a reference from another is not supported (for example, a 1080i 50 input will not work with 1080i 60 reference.)

Input Format	Reference Formats					
	PAL	720p 25	720p 50	1080p 25	1080sf 25	1080i 50
PAL 50 Hz ¹	x					
576i, 50 Hz 2(625) ²	x		x			x
720p, 25 Hz ³	x		x			x
720p, 50 Hz ³	x		x			x

Reference Formats

Input Format	PAL	720p 25	720p 50	1080p 25	1080sf 25	1080i 50
1080p, 25 Hz ³	x		x			x
1080sf, 25 Hz ³	x		x			x
1080i, 50 Hz ³	x		x			x

¹ Available with Opt. CPS.

² Available with WFM7100 Opt. SD or with WFM6100 Opt SD

³ Available with WFM7000 and WFM7100 Opt HD only

Reference Formats

Input Format	NTSC	720p 23.98	720p 29.97	720p 59.94	1080p 23.98	1080sf 23.98	1080p 29.97	1080sf 29.97	1080i 59.94
NTSC 59.94 Hz ¹	x								
483i, 59.94 Hz (525) ²	x			x					x
720p, 23.98 Hz ³	x			x	x	x			x
720p, 23.97 Hz ³	x			x					x
720p, 59.94 Hz ³	x			x	x	x			x
1080p, 23.98 Hz ³	x			x	x	x			x
1080sf, 23.98 Hz ³	x			x	x	x			x
1080p, 29.97 Hz ³	x			x					x
1080sf, 29.97 Hz ³	x			x					x
1035i, 59.94 Hz ³	x			x					x
1080i, 59.94 Hz ³	x			x					x

¹ Available with Opt. CPS.

² Available with WFM7100 Opt. SD or with WFM6100 Opt SD

³ Available with WFM7000 and WFM7100 Opt HD only

Reference Formats

Input Format	720p 24	720p 30	720p 60	1080p 24	1080sf 24	1080p 30	1080sf 30	1080i 60
720p, 24 Hz ¹			x	x	x			x
720p, 30 Hz ¹			x					x
720p, 60 Hz ¹			x	x	x			x
1080p, 24 Hz ¹			x	x	x			x
1080sf, 24 Hz ¹			x	x	x			x
1080p, 30 Hz ¹			x					x
1080sf, 30 Hz ¹			x					x
1035i, 60 Hz ¹			x	x	x			x
1080i, 60 Hz ¹			x	x	x			x

¹ Available with WFM7000 and WFM7100 Opt HD only

AES A/B Connectors

1. These BNC connectors support AES audio inputs.

- A1-2 In
- A3-4 In
- A5-6 In
- A7-8 In
- B1-2 I/O ¹
- B3-4 I/O ¹
- B5-6 I/O ¹
- B7-8 I/O ¹

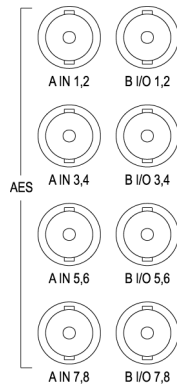

1890-007

Options DS, AD, DD, DDE

¹ The AES B connectors can be configured to output embedded audio channels, decoded Dolby, or the AES A inputs.

Analog Input/Output Connector

The Analog I/O connector is used to receive and send analog signals. The Analog I/O connector is a 62-pin, D-subminiature connector. Pin assignments and pin names are listed in the following figure and table.



CAUTION. Use care when connecting the Analog Audio Output. Refer to the instrument Specifications to ensure that the Audio Load and Output Power meet specifications. Exceeding Analog Audio Output Power may result in damage to the instrument.

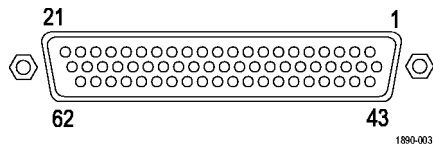

1890-003

Option AD

Pin	Description
1 ANALOG_INPUT_A1_P	Balanced differential analog audio input- Ch. 1, line A, positive.
2 ANALOG_INPUT_B1_P	Balanced differential analog audio input- Ch. 1, line B, positive.
3 ANALOG_INPUT_A2_P	Balanced differential analog audio input- Ch. 2, line A, positive.
4 ANALOG_INPUT_B2_P	Balanced differential analog audio input- Ch. 2, line B, positive.
5 ANALOG_INPUT_A3_P	Balanced differential analog audio input- Ch. 3, line A, positive.
6 ANALOG_INPUT_B3_P	Balanced differential analog audio input- Ch. 3, line B, positive.
7 ANALOG_INPUT_A4_P	Balanced differential analog audio input- Ch. 4, line A, positive.
8 ANALOG_INPUT_B4_P	Balanced differential analog audio input- Ch. 4, line B, positive.
9 ANALOG_INPUT_A5_P	Balanced differential analog audio input- Ch. 5, line A, positive.

10 ANALOG_INPUT_B5_P	Balanced differential analog audio input- Ch. 5, line B, positive.
11 ANALOG_INPUT_A6_P	Balanced differential analog audio input- Ch. 6, line A, positive.
12 ANALOG_INPUT_B6_P	Balanced differential analog audio input- Ch. 6, line B, positive.
13 GND	
14 ANALOG_OUTPUT_1_P	Balanced differential analog audio output- Ch. 1, positive.
15 ANALOG_OUTPUT_2_P	Balanced differential analog audio output- Ch. 2, positive.
16 ANALOG_OUTPUT_3_P	Balanced differential analog audio output- Ch. 3, positive.
17 ANALOG_OUTPUT_4_P	Balanced differential analog audio output- Ch. 4, positive.
18 ANALOG_OUTPUT_5_P	Balanced differential analog audio output- Ch. 5, positive.
19 ANALOG_OUTPUT_6_P	Balanced differential analog audio output- Ch. 6, positive.
20 ANALOG_OUTPUT_7_P	Balanced differential analog audio output- Ch. 7, positive.
21 ANALOG_OUTPUT_8_P	Balanced differential analog audio output- Ch. 8, positive.
22 ANALOG_INPUT_A1_N	Balanced differential analog audio input- Ch. 1, line A, negative.
23 ANALOG_INPUT_B1_N	Balanced differential analog audio input- Ch. 1, line B, negative.
24 ANALOG_INPUT_A2_N	Balanced differential analog audio input- Ch. 2, line A, negative.
25 ANALOG_INPUT_B2_N	Balanced differential analog audio input- Ch. 2, line B, negative.
26 ANALOG_INPUT_A3_N	Balanced differential analog audio input- Ch. 3, line A, negative.
27 ANALOG_INPUT_B3_N	Balanced differential analog audio input- Ch. 3, line B, negative.
28 ANALOG_INPUT_A4_N	Balanced differential analog audio input- Ch. 4, line A, negative.
29 ANALOG_INPUT_B4_N	Balanced differential analog audio input- Ch. 4, line B, negative.
30 ANALOG_INPUT_A5_N	Balanced differential analog audio input- Ch. 5, line A, negative.
31 ANALOG_INPUT_B5_N	Balanced differential analog audio input- Ch. 5, line B, negative.
32 ANALOG_INPUT_A6_N	Balanced differential analog audio input- Ch. 6, line A, negative.
33 ANALOG_INPUT_B6_N	Balanced differential analog audio input- Ch. 6, line B, negative.
34 GND	
35 ANALOG_OUTPUT_1_N	Balanced differential analog audio output- Ch. 1, negative.
36 ANALOG_OUTPUT_2_N	Balanced differential analog audio output- Ch. 2, negative.
37 ANALOG_OUTPUT_3_N	Balanced differential analog audio output- Ch. 3, negative.
38 ANALOG_OUTPUT_4_N	Balanced differential analog audio output- Ch. 4, negative.
39 ANALOG_OUTPUT_5_N	Balanced differential analog audio output- Ch. 5, negative.
40 ANALOG_OUTPUT_6_N	Balanced differential analog audio output- Ch. 6, negative.
41 ANALOG_OUTPUT_7_N	Balanced differential analog audio output- Ch. 7, negative.
42 ANALOG_OUTPUT_8_N	Balanced differential analog audio output- Ch. 8, negative.
43—62	No connection.

Connecting Signals. When connecting audio signals to the Analog Input connector, you can use either balanced or unbalanced signals. If you connect unbalanced signals to the inputs, you do not have to ground the unused lead (grounding the unused lead can reduce noise).

When connecting the Analog Output connectors, you can connect them as balanced or unbalanced. However, if you connect the balanced outputs to an unbalanced input, you must ground the unused lead. You can ground either lead.

NOTE. Note that grounding the unused lead does not attenuate the output but it does halve the clipping level. Therefore, you must attenuate the output by at least 6 dB to avoid clipping. The output signal level in unbalanced mode is double the signal level in balanced mode.

Units that have both analog and digital capability can have AES or embedded inputs converted to analog and then routed to the six balanced outputs. Embedded audio can be output to the AES B connector (when it is configured as an output). AES A can also be routed to the AES B connector. Decoded Dolby can also be routed to the analog output connector.

EXT DISPLAY Connector Pin Assignment

This is the display output. The display resolution is 1024 x 768. The output is compatible with standard analog PC monitors, either CRT or LCD-based. The EXT DISPLAY connector is a 15-pin D-type connector with socket contacts.

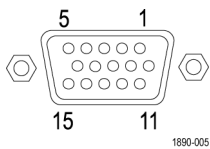

Pin	Pin name
1	Red Video
2	Green Video
3	Blue Video
4	Not connected
5	Ground
6	Red Ground
7	Green Ground
8	Blue Ground
9	+5 V (for monitor EEPROM)
10	Not Connected
11	Not Connected
12	ID Bit
13	Horizontal Sync
14	Vertical Sync
15	ID Clock

Pix Mon Connector Pin Assignment

This is the video picture output. The output is compatible with standard analog PC monitors, either CRT or LCD-based. The PIX MON connector is a 15-pin D-type connector with socket contacts.

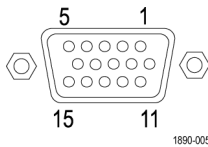

Pin	Pin name
1	Red Video
2	Green Video
3	Blue Video
4	Not connected
5	Ground
6	Red Ground
7	Green Ground
8	Blue Ground
9	Not Connected
10	Not Connected
11	Not Connected
12	Not Connected
13	Horizontal Sync
14	Vertical Sync
15	Not Connected

Remote Connector Pin Assignment

The REMOTE connector interface uses ground closures for remote control and indicating to external equipment when alarms have occurred. The input of LTC is through the REMOTE connector. The REMOTE connector is a 15-pin D-type connector with socket contacts.

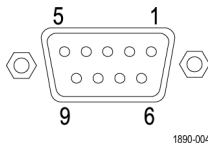

Pin	Pin name
1	Ground
2	Time Code Positive (IN)
3	Time Code Negative (IN)
4	Ground
5	Ground Close Output. Has weak pull-up with a diode to +5 V so you can get logic swing without pull up. (OUT)
6	Preset Recall 1. Grounding this pin is will select the associated preset. (IN)
7	Preset Recall 2. Grounding this pin is will select the associated preset. (IN)
8	Preset Recall 3. Grounding this pin is will select the associated preset. (IN)
9	Preset Recall 4. Grounding this pin is will select the associated preset. (IN)

Ethernet Connector

The waveform monitor provides a 10/100 BaseT Ethernet interface. The Ethernet connector is a standard RJ-45 connector.

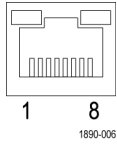

To Select a Measurement

1. After you have selected a tile, you can choose what to display in it. The Display is independent for each tile.

1. Select a tile by touching it.
2. Push the button corresponding to the measurement that you want to display in the selected tile.
3. Select the measurement you want to display from the Main pop-up menu.
4. Repeat steps 1 through 3 until you have selected measurement displays for all tiles that you want to define.



5. To display the same measurements in more than one tile, select each tile in sequence, and then choose the same measurement for each one.

The display at right shows the display with WFM selected for three tiles with different sweep settings.

NOTE. The Audio and DataList displays can be displayed in only one tile at a time.



To Set Display and Measurement Parameters

You adjust display parameters and measurement settings using soft key menus. Soft key menus appear at the bottom of the display and for measurements, the settings apply to the active tile. For example, suppose you displayed a WFM measurement in three tiles. The Sweep setting for each tile is set independently, so even though the soft key menu for each tile would be identical.

1. Select the tile whose parameters you want to change by touching the tile (not necessary in 1-View mode).
2. Select the parameter you want to change from the soft key menu.
3. Some settings are accessed from the Settings soft key.

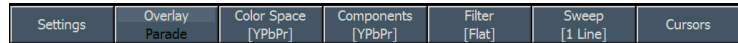

Depending on the setting, you might need to make selections from a submenu.

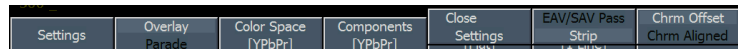

Some settings provide multiple choices within the submenu. For example, when selecting the components that are shown in the WFM display, you choose from all the available components within one submenu.

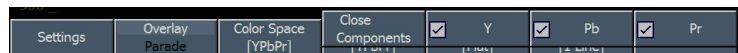
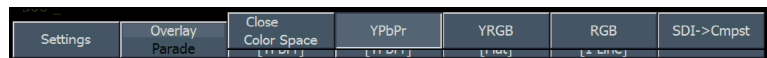

NOTE. The selections in a submenu can change depending on settings.

To Select Among Video Inputs

You can connect serial digital component signals and select them for display in a tile. Depending on the model and options that you ordered, you can connect standard-definition component signals, high-definition component signals and analog composite signals.

To select a component input

1. Connect any digital component video signals to the A and B SDI inputs on the rear panel.

NOTE. The A and B inputs are separate inputs and cannot be used as a loop-through path.



SDI A



SDI B



SDI OUT



CLOCK OUT

1890-008

Option Eye/Phy

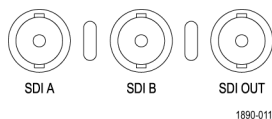

Option SD/HD

2. Connect any analog composite signals to the A or B Composite inputs at the rear panel. (On Option CPS equipped instruments only.)
3. For the composite inputs, terminate the loop-through input properly at the rear panel for any inputs that are not routed to another device.

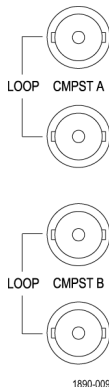

Option CPS

4. Press the **IN/OUT** button to display the In/Out menu.
5. Press the soft key for the input you want to display.

5251 59.94 Mon Apr 24 15:59:48 ID: FFFF
SDI Input A Ref: Internal Hide Menu ? Embd: FFFF
VITC: 11:5322:012

True Peak Input: EMB A

1	2	3	4	5	6	7	8
RGB	Y/Cb/Cr	Y/Cb/Cr	Y/Cb/Cr	UNLOCKED	UNLOCKED	UNLOCKED	UNLOCKED

dBFS: 0, -10, -20, -30, -40, -50, -60

Statistics:

Statistics	Status	Err Secs	Err Fields	% Err Fields
RGB Gamut Error	Fail	23023	1379567	100.0000 %
Compst Gamut Error	OK	479	10121	0.7336 %
Luma Gamut Error	Fail	23023	1379568	100.0000 %
F2 CRC Error	Missing	0	0	0.0000 %
AP CRC Error	Missing	0	0	0.0000 %
EDH Error	Missing	0	0	0.0000 %

Video Session: Input: SDI A, Signal: Unlocked, Format: Auto 5251 59.94, Data Collect: Running, Run Time: 0 d, 06:23:44

Settings Digital Input A Digital Input B Analog Input A Analog Input B Int Ref Ext Ref

To Set Gain, Horizontal Magnification and Sweep

Each tile maintains its own settings independent of the other tiles. These settings include Gain, Horizontal Magnification and Sweep. For instance, when you switch a tile to a different measurement, the Gain, Horizontal Magnification, and Sweep settings will be changed to what they were the last time the selected measurement was displayed in the tile. As the procedure below indicates, Gain, Horizontal Magnification, and Sweep do not apply to all display types.

To set Gain:

1. Select the tile whose gain you want to adjust. (This will restore the menu for the tile if it is not currently displayed.)
2. Push the MAG/GAIN button. (If MAG/GAIN is not available for the tile you have selected, a message is displayed to let you know that MAG/GAIN is not available.)
3. To set a fixed gain, touch the **V Gain** readout and use the large knob to change the gain. You can also touch one of the fixed gain soft keys.
4. To set the VAR(iable) Gain, touch the **Var Gain Enable** soft key so it is checked. Set the gain that you want using the large knob.

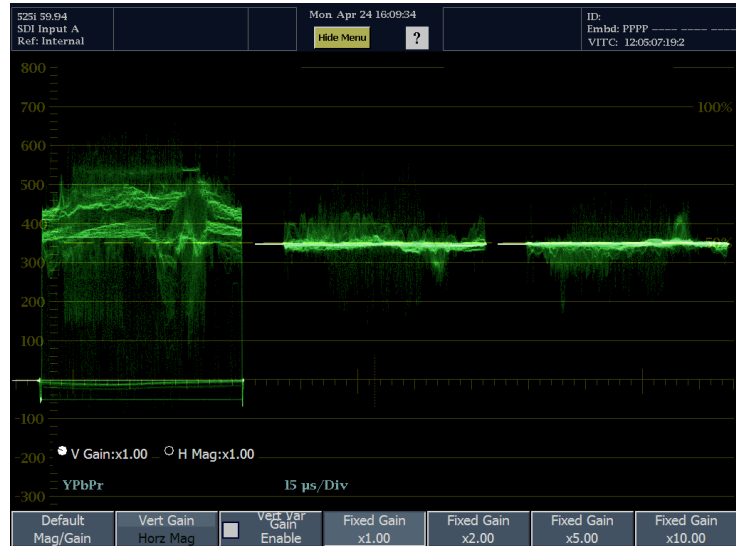

To set Horizontal Magnification:

1. Select the tile whose horizontal magnification you want to adjust. (This will restore the menu for the tile if it is not currently displayed.)
2. Push the MAG/GAIN button. (If MAG/GAIN is not available for the tile you have selected, a message is displayed to let you know that MAG/GAIN is not available.)
3. Touch the Vert Gain / Horz Mag soft key to highlight **Horz Mag**.
4. To set the horizontal magnification, touch the **H Mag** readout and use the large knob to change the magnification. You can also touch one of the Fixed Mag soft keys.
5. Select **Mag Best View** to optimize the magnification to show the blanking interval for two line and two field displays. Line the blanking up on the center graticule, and then press Mag Best View to expand.

NOTE. You can also change the V Gain and H Mag values by touching the readouts and using the large knob to adjust their values.



NOTE. If either V Gain or H Mag is selected, you can switch to adjusting the other value by pressing the SELECT button.

To set Sweep:

1. Select the tile whose sweep you want to adjust. (This will restore the menu for the tile if it is not currently displayed.)
 2. Touch the **Sweep** soft key.
 3. Select the desired sweep from the submenu.
- The choices available in the WFM display depend on the Overlay / Parade mode setting.

- Overlay – Choices available are: 1 Line, 2 Lines, 1 Field, and 2 Fields.
- Parade — Choices available are: 1 Line or 1 Field.

For Eye displays, the choices available are: 1 Line or 1 Field.

For Jitter displays, the choices available are: 1 Line, 2 Lines, 1 Field, and 2 Fields.



To Use Presets

A Preset is a saved version of the instrument settings in a particular configuration. Using Presets saves you time because you only need to press a couple of buttons to change a range of instrument settings to meet a specific measurement need. Presets are created and recalled using the PRESETS button on the front panel.

NOTE. In addition to instrument settings, User menus are stored in Presets. This allows you to create Presets that contain User menus tailored to specific applications.

To Save a Preset

1. Set up the instrument as you want it.
2. Push the **PRESETS** button.
3. Touch the **Settings** soft key.
4. Touch the **Save Preset** soft key.
5. Select a preset number (such as "A2" or "C3") in the grid.
6. When prompted to rename, select **Yes** to create a descriptive, 11-character name for the Preset, or select **No** to save the preset using the default label (such as "A2").

The setup will be stored for later recall.



To Recall an Existing Preset

1. Push the **PRESETS** button.
2. Touch one of the soft keys in the Presets menu. Unless you have renamed them, they will be labeled A1–A5.

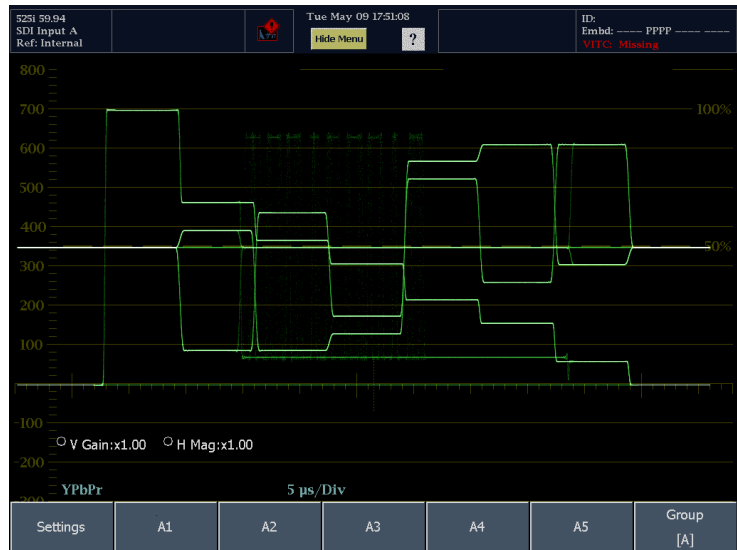

- If a the preset you want is not in the displayed group, Touch the **Group** soft key and select the appropriate group from the submenu.

The front panel setup will switch to the saved preset corresponding to the soft key pressed.

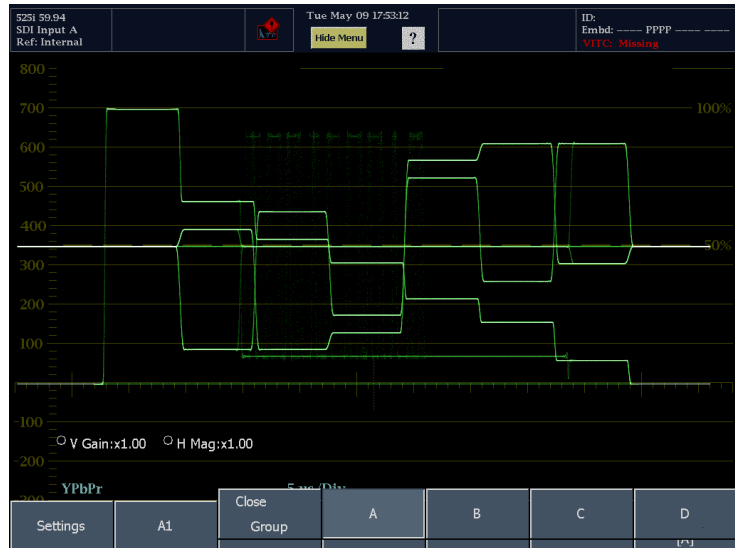

To Copy a Preset to or from a USB Flash Drive

- Insert a flash drive into the USB port on the front panel.

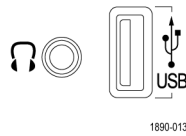

- Touch the **PRESETS** button.
- Touch the **Settings** soft key.

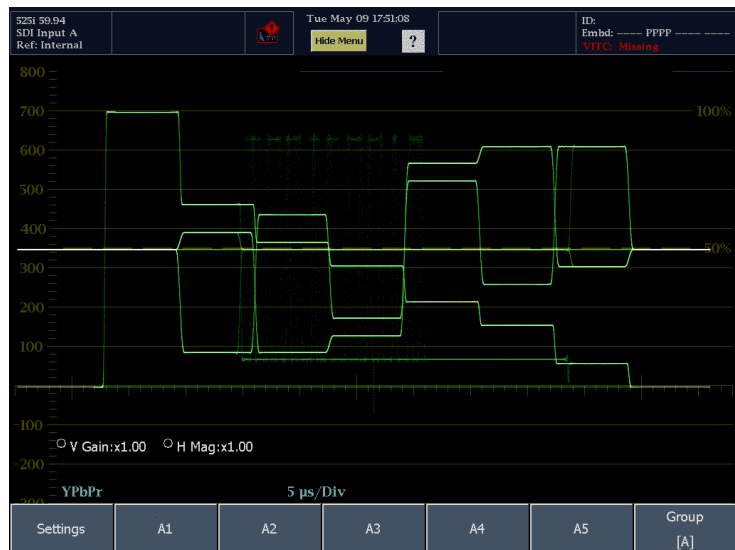

- Touch the **Copy Preset(s)** soft key.

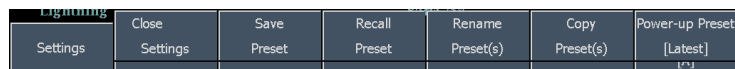

5. Verify that the USB flash drive is recognized (a description of the drive will appear after **USB Storage Device**). If it is not recognized, touch the **Reset** soft key to mount the flash drive.
 - If the flash drive is still not recognized, the flash drive may not be compatible; try using another flash drive.
6. Touch the **Source** soft key. **Internal** is the default Source location.
7. If you want to copy a Preset from the instrument to the USB flash drive, touch the Preset shown in the Source Presets list that you wish to copy or touch **All** to copy all of the Presets, or select a group to copy.
 - Once you touch a Preset label, the **Source Location** and **Source Presets** labels will change to **Destination Location** and **Destination Presets**.
8. If you want to copy a Preset from the USB flash drive to the instrument, touch the source location (if more than source is listed). Then touch the Preset in the Source Presets list that you want to copy to the instrument.
9. Select a destination location from the list (either Internal or USB depending on the direction you want to copy the Preset).
 - If you are copying to the USB flash drive, you must copy the presets to a folder. You can create a new folder in which to save the Preset using the **New USB Folder** soft key.

NOTE. The only folders accessible from Copy Presets are the subfolders within the root-level folders that the instrument automatically creates.

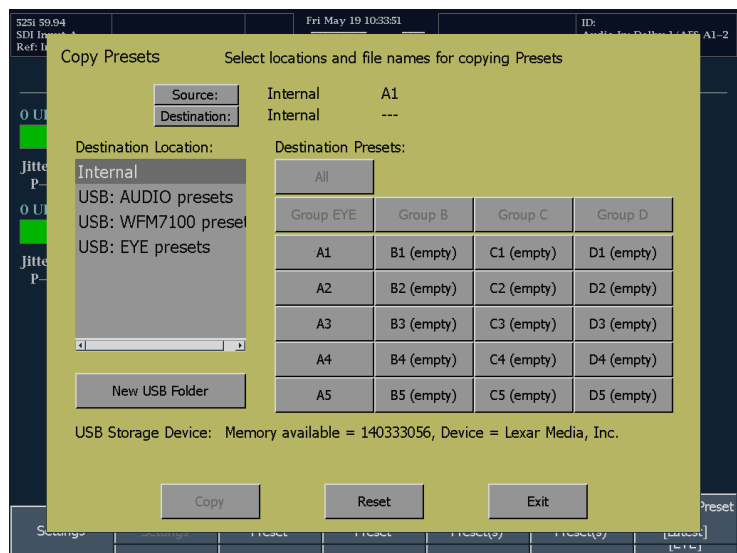
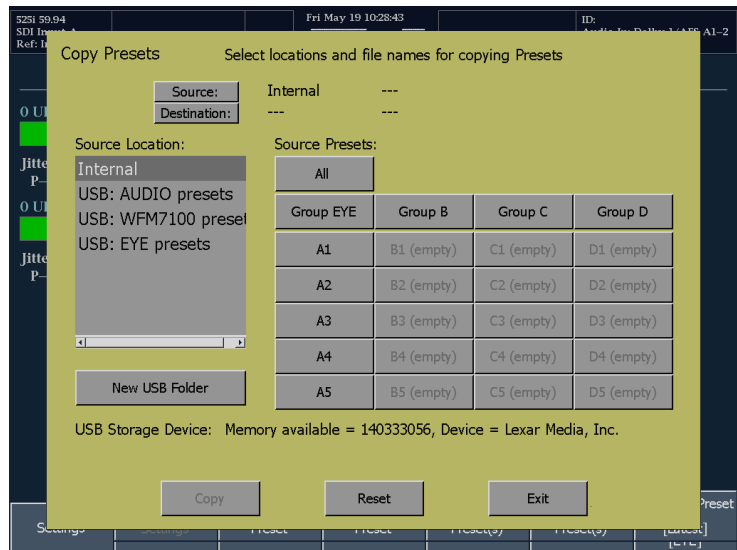

10. Touch the **Copy** soft key to save the Preset.

Once the copy is complete, the instrument is ready to copy another Preset.

11. When you are ready to remove the USB flash drive from the instrument, press **MAIN**.
12. From the Main menu, touch the USB **Unmount** soft key and then remove the USB flash drive from the instrument.

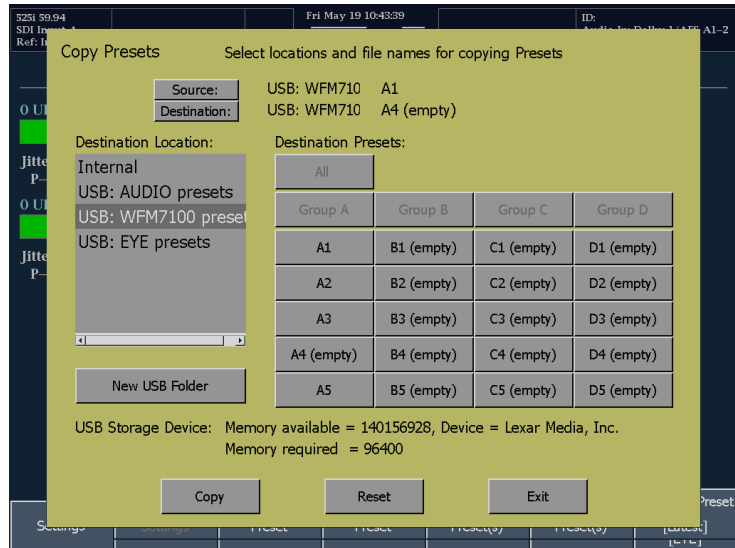

To Recall the Factory Preset

1. Push the **PRESET** button.
2. Touch the **Settings** soft key to display the submenu.
3. From the Settings submenu, touch the **Recall Preset** soft key.
4. From the menu in the center of the display, touch the **Factory** soft key.



To Change the Power-up Preset

1. Push the **PRESET** button.
2. Touch the **Settings** soft key to display the submenu.

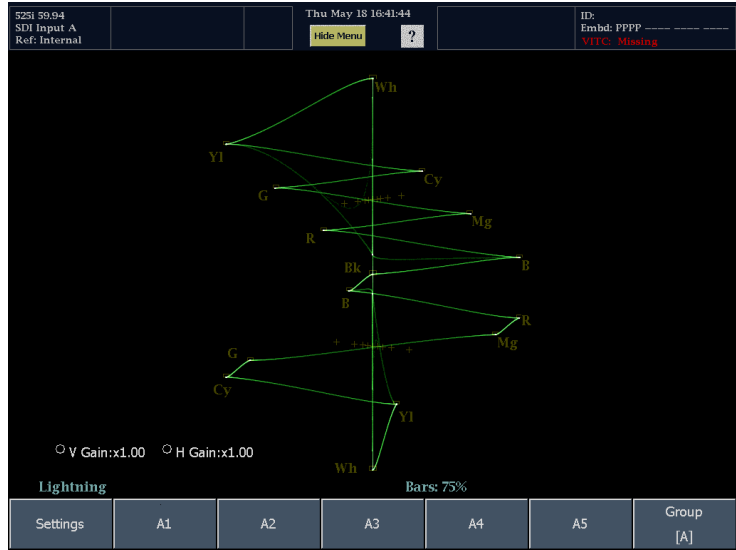

3. From the Settings submenu, touch the **Power-up Preset** soft key.



4. From the menu in the center of the display, choose any available preset for the instrument to use at power up.

NOTE. The "Latest" preset is the instrument setup at the time the instrument was last shutdown using the Shutdown command (MAIN > Standby > Shutdown). It is not the instrument setup the last time power was removed from the instrument.



To Rename a Preset or Group

1. Push the **PRESET** button.
2. Touch the **Settings** soft key to display the submenu.

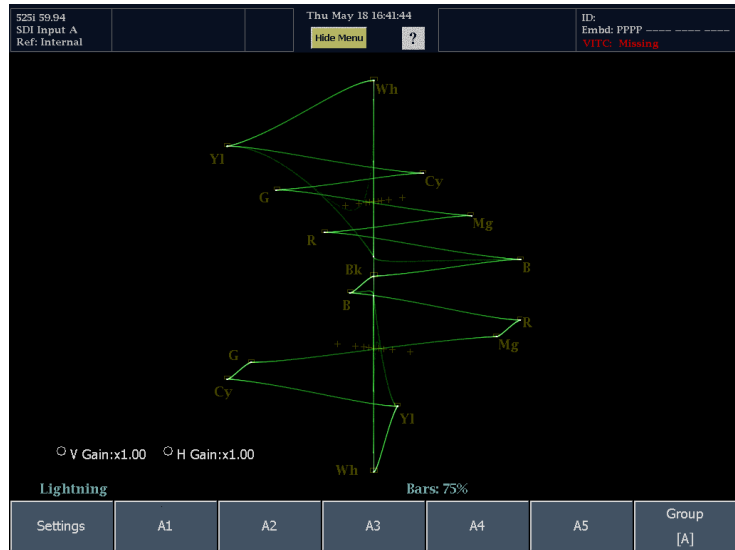

3. From the Settings submenu, touch the **Rename Preset(s)** soft key.



4. From the menu in the center of the display, choose the Source location if necessary.

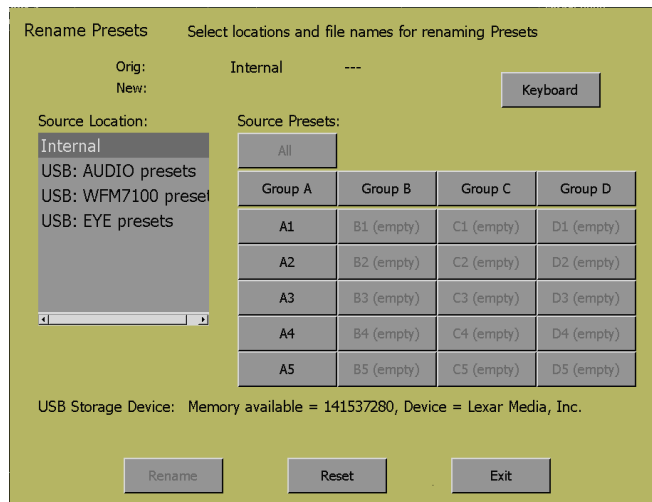

5. Touch the soft key for the preset or group name that you want to change.

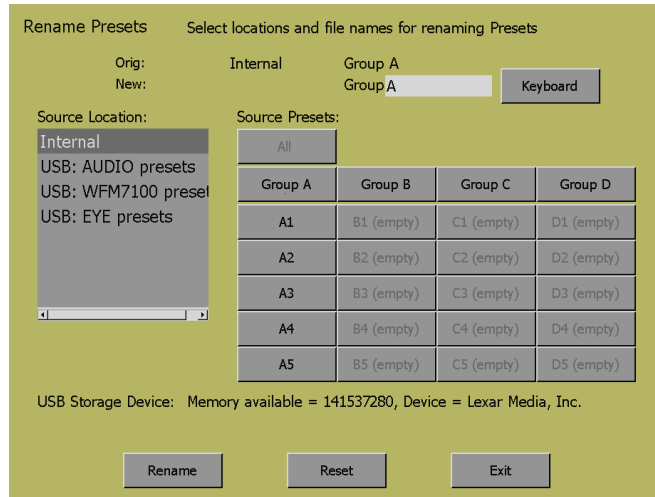

6. Touch the **Keyboard** soft key and type in a new name for the selected preset or group. Press Return to save the new name.

NOTE. Preset names are limited to 11 characters. Group names cannot exceed 8 characters.

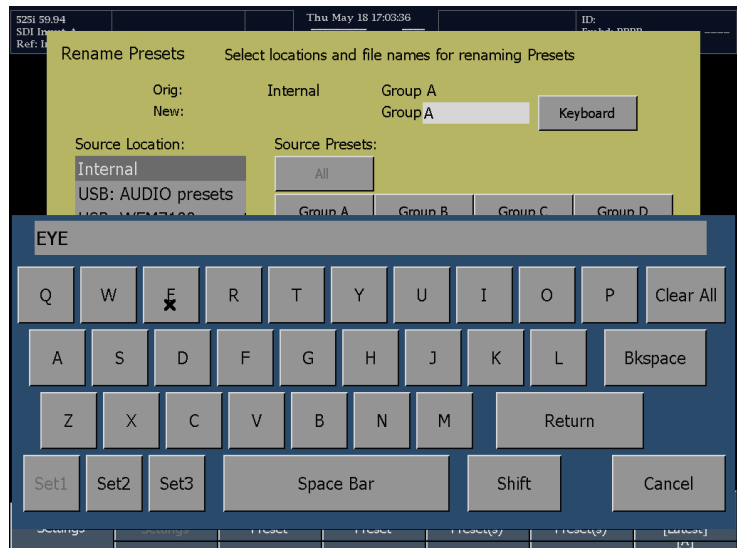

- 7. Press the **Rename** soft key to apply the new name.
- 8. Press the **Exit** soft key when you are finished renaming presets.

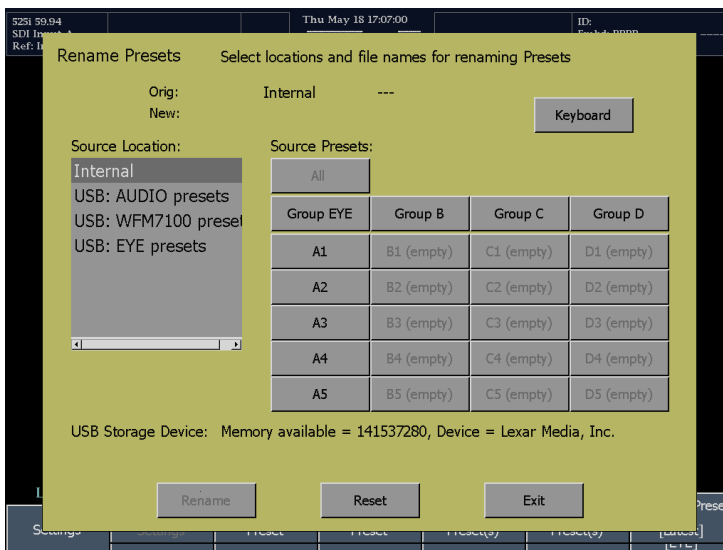

To Measure Waveforms with Cursors

Cursors enable you to measure time or voltage on a waveform. Cursors are available in tiles set to Waveform, Eye, or Jitter mode.

To display and adjust cursors:

1. Choose a tile that is currently displaying a waveform, eye pattern, or Jitter display.

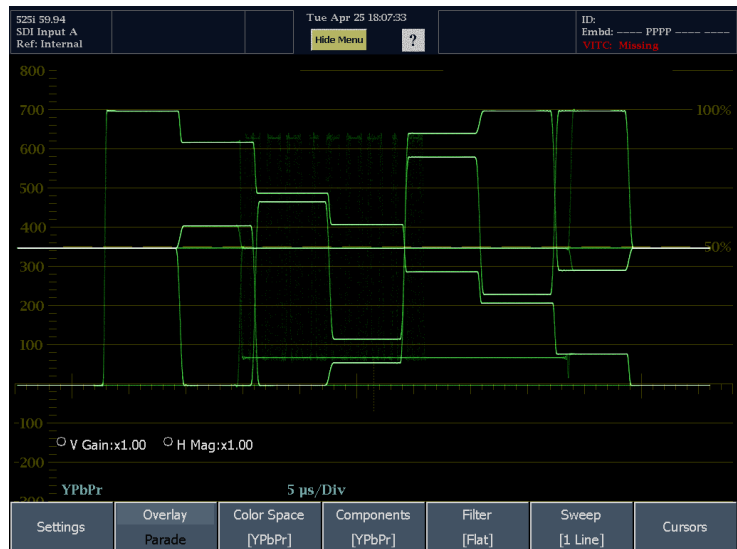

2. Touch the **Cursors** soft key to display the Cursors submenu.
3. To display cursors, touch the soft key for the type of cursors you want displayed so that the box is checked.
4. Touch **Track / Independent** to specify how cursor pairs move with respect to each other.
 - Select **Track** if you want both cursors (V1/V2 or T1/T2) to move together as a single unit.
 - Select **Independent** to move each cursor by itself.



5. To move a cursor, touch the cursor readout on the display and turn the large knob to move the selected cursor on the waveform. The active cursor readout appears in yellow with a filled-in knob icon.
6. Repeat the process to adjust the other cursor (if cursors are set to independent).
7. Read the cursor measurement in the Cursors readout.

NOTE. If the display is in Parade mode, do not try to measure from one element to the next. Stay within single component for accurate measurements.

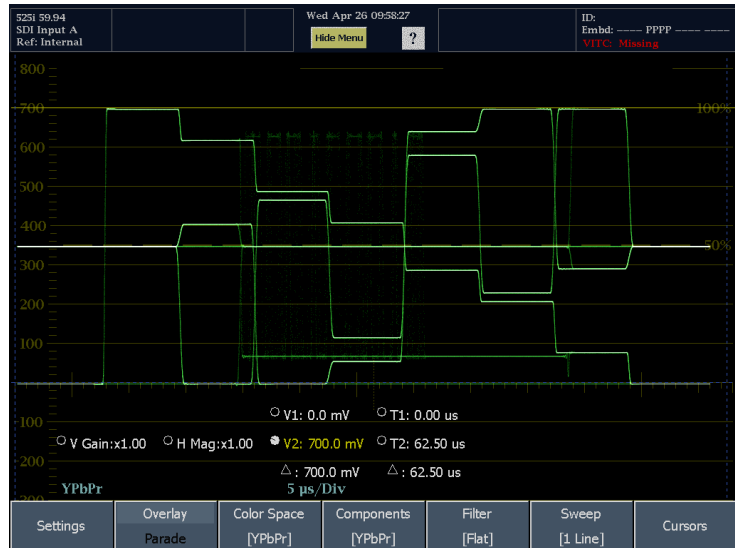

Other Usage Tips

If you use other functions, such as Line Select, while cursors are active, the knob will be assigned to those other functions. Touch one of the cursor readouts to transfer the knob control back to cursors.

You can display independent cursors in all four tiles at the same time, although you will only be able to change the cursors in the active tile.

Cursors track the live trace, so they may not be correctly registered on a captured trace.

Press the **SELECT** button to change the cursor assigned to the knob. If both voltage and time cursors are displayed, repeatedly pressing Select will cycle the knob assignment through all the displayed cursors. If only one set of cursors is displayed, pressing the Select button will cycle the knob assignment between cursor 1 and cursor 2.

To Capture the Display

Use the Capture function to capture the current image for traces (waveform, gamut displays, and vector) if selected. Capture is useful for comparing sources or for capturing transient events. The frozen image is shown in a different color to distinguish it from the live image. Use **Capture Trace / Capture Buffer** to freeze a display you want to keep or show to someone else. In this application, setting the Capture Display On setting and disabling the Live Display On setting might be best. For comparing sources, the enabling both the Live Display On and Capture Display On modes is useful.

You can capture waveforms two ways: as a trace and as a buffer. Buffer and Trace modes are different in the following ways: Trace mode takes a snapshot of the display, so it cannot change size or mode after the freeze.

- In Buffer mode, a frame of the input signal is captured. This allows it to be redisplayed as the display mode and size is changed. For example you can perform a buffer capture in waveform mode, and then change to vector to see the same data in the new display. Buffer mode also resizes the capture image as you go from four-tile to full screen mode.
- Trace mode capture works in both tile and full-screen modes, but frozen images do not change from tile to full or visa-versa. The frozen image is still available if you go back to tile mode.

Since the Buffer method captures a whole frame of the input, it can be redisplayed for different display types, Vector, Diamond, or Arrowhead. Buffer mode supports a triggering capability, which initiates a capture when specific errors occur. Buffer mode does not work on physical layer displays such as Eye and Jitter, nor can it be used with composite signals. Trace mode works with all the waveform displays. Use this method to capture only the displayed trace from a video frame. Captures made using this method do not include the associated decoded data.

To capture a display:

1. Press the front-panel CAPTURE button. This displays the Capture menu.
2. Press the **Settings** soft key.

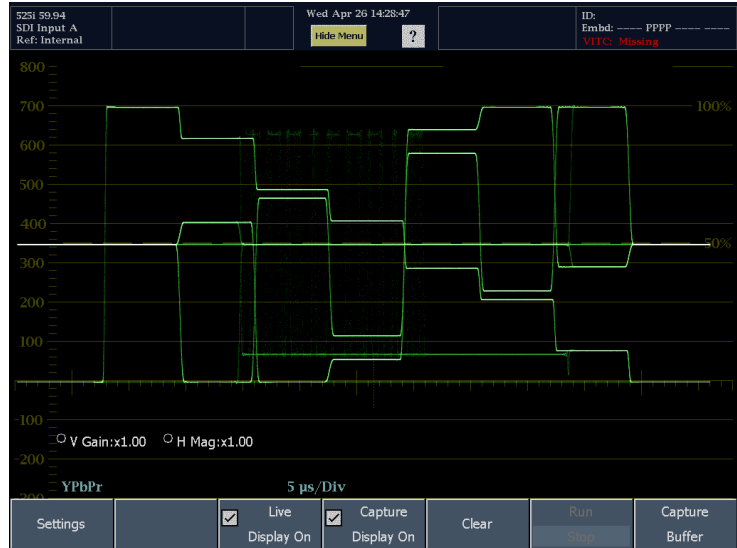

3. Touch the **Buffer / Trace** soft key to set the type of Capture. Touch Close Settings to remove the submenu.
4. To display the capture, be sure the **Capture Display On** soft key is checked.

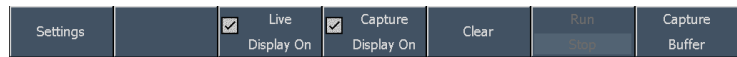
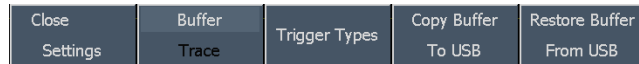

NOTE. The Live Display On setting is specific to the tile selected, and can be set independently for each tile.

5. To capture the trace or buffer, touch the **Capture Trace** or **Capture Buffer** soft key.

- Only one capture can be active at a time. After a capture has been performed, the **Freeze Active** icon appears in the Status Bar, the Capture soft key is no longer selectable, and the CAPTURE button on the front panel is illuminated.
- When Freeze Active is displayed, another capture cannot be made until the current capture is cleared.

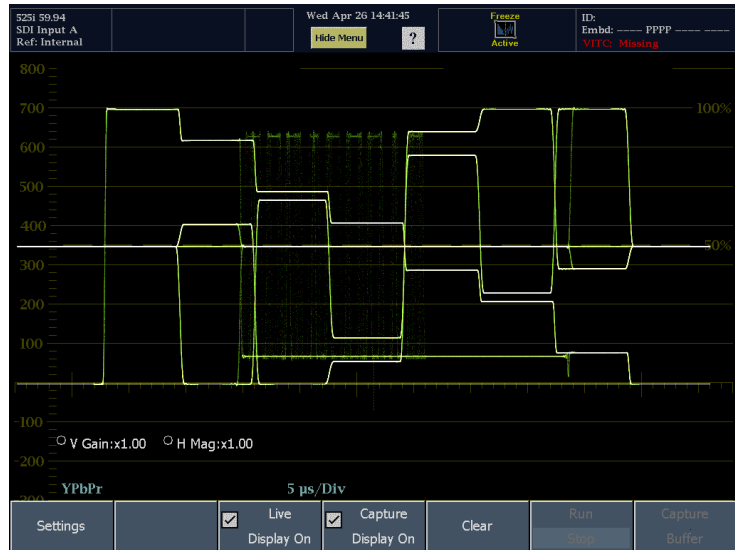

Triggering a Capture Based on Error Events

You can set up the waveform monitor to initiate a Capture when certain errors occur. This triggered Capture mode requires that the capture type be set to Buffer.

To initiate a capture based on an error event:

1. Select the tile you want to capture.
2. Press the **CAPTURE** button. This displays the Capture menu.
3. Press the Settings soft key.

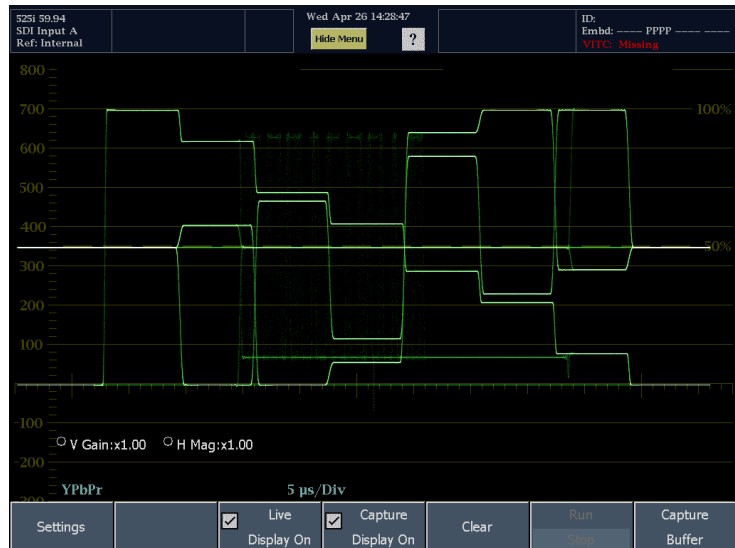

4. Touch **Buffer / Trace** so that Buffer is selected (Buffer is displayed in white text.)
5. Touch the **Trigger Types** soft key to select the type of error that will trigger the capture. Select the trigger type(s) you want to initiate a capture.
6. Touch **OK** to save your selections.
7. Touch **Close Settings** to remove the submenu.

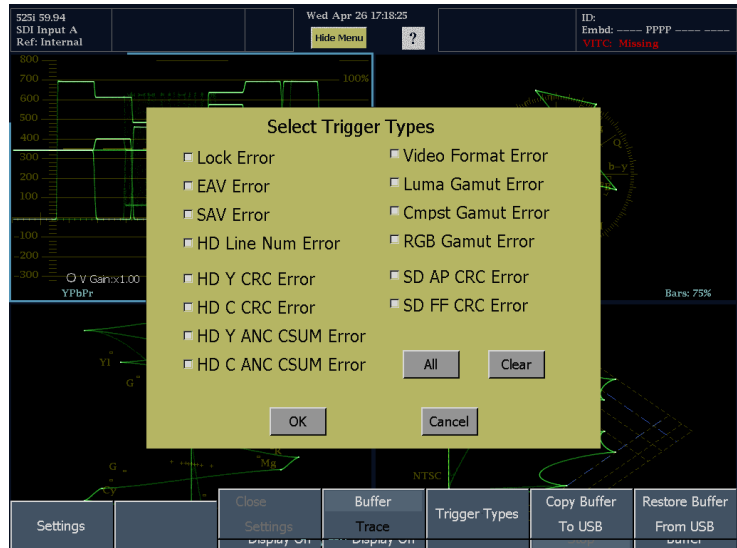

8. To initiate the trigger capture process, touch the **Run / Stop** soft key.

The waveform monitor will perform a buffer capture when one of the selected trigger events occurs.

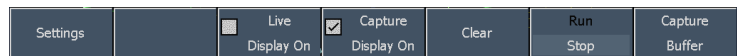

Clearing the Capture Buffer

1. Press the CAPTURE button to display the Capture menu.
2. Touch the **Clear** soft key.

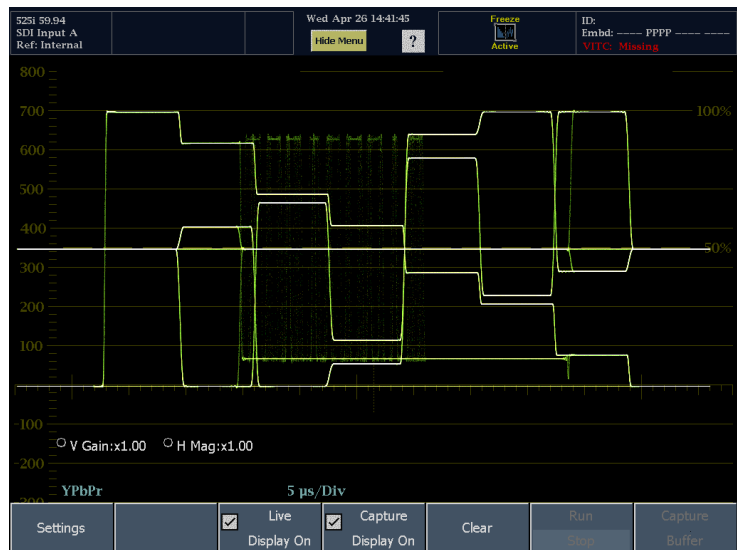
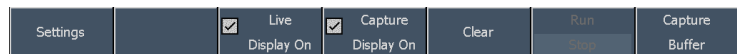

Copying the Capture Buffer to a USB Flash Drive

1. Insert a flash drive into the USB port on the front panel.



1890-013

2. Touch the **CAPTURE** button to display the Capture menu.



3. Touch the Settings soft key to display the submenu.



4. Touch the Copy Buffer To USB soft key. This displays the Copy Capture Buffer dialog window.

5. Verify that the USB flash drive is recognized (a description of the drive will appear after **USB Storage Device**). If it is not recognized, touch the **Reset** soft key to mount the flash drive.

- If the flash drive is still not recognized, the flash drive may not be compatible; try using another flash drive.

6. Touch the **Keyboard** soft key to display a keyboard you can use to enter a name for the file.

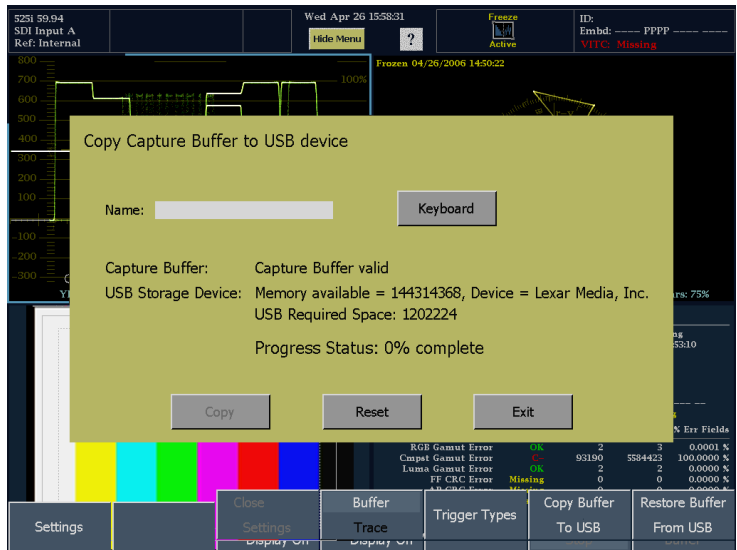

7. Enter a name for the file and touch **Return** to save the name.

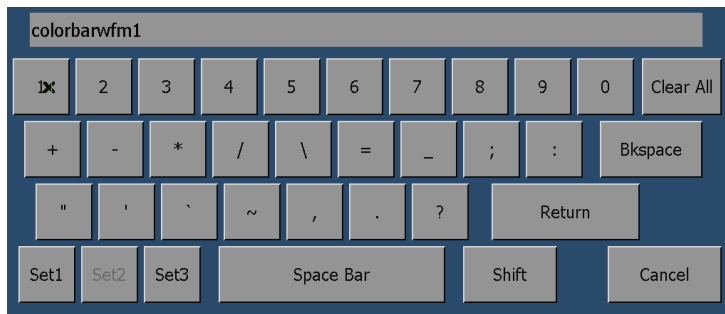

8. Touch the Copy soft key to save the buffer capture to the USB Flash Drive. The waveform monitor will indicate its progress saving the file to the flash drive with the Progress Status readout. While the copy is occurring, the Capture menu will flash to indicate the copy is in process. The waveform monitor will display **Operation Complete** when the copy is finished.
9. When you are ready to remove the USB flash drive from the instrument, press MAIN.
10. From the Main menu, touch the USB **Unmount** soft key and then remove the USB flash drive from the instrument.

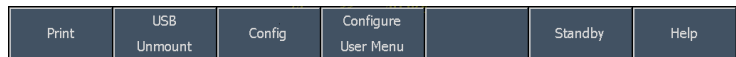
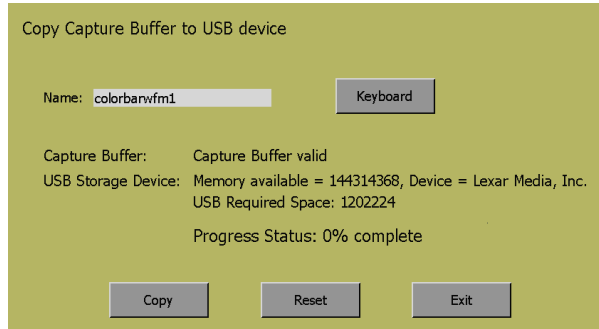

Restoring a Buffer Capture from a USB Flash Drive

1. Insert a flash drive into the USB port on the front panel.
2. Touch the **CAPTURE** button to display the Capture menu.
3. Touch the **Settings** soft key to display the submenu.
4. If the USB Flash Drive is not recognized (a description of the drive will appear after **USB Storage Device**), touch the **Reset** soft key to mount the flash drive.
 - If the flash drive is still not recognized, the flash drive may not be compatible; try using another flash drive.
5. Select the desired Capture from the list.
6. Touch **Restore** to copy the file to the waveform monitor.
7. When the operation is complete, touch **Exit** to remove the dialog.

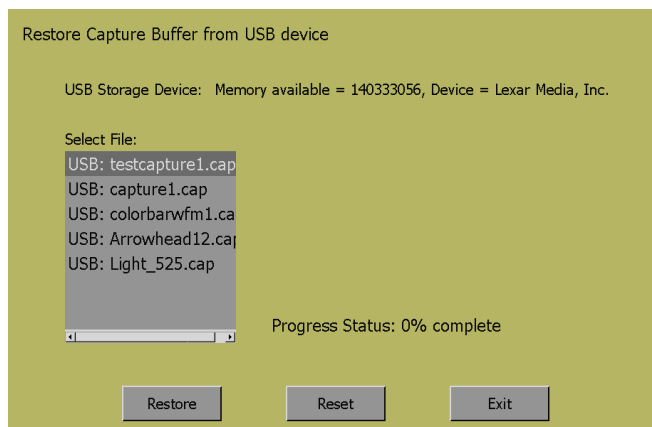
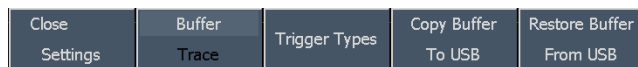
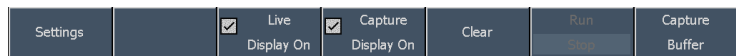
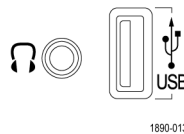

To Set Line Select Mode

To Toggle Line Select Mode:

1. Select the tile containing the display for which you want to set Line Select Mode.

NOTE. *Line Select Mode can only be active on one tile at a time.*

2. Push **LINE SEL** to toggle Line Select Mode on or off. When on, the tile displays the selected line information only. The Line selection menu appears at the bottom of the selected tile.

NOTE. *If the LINE SEL button is lit but the Line Select menu is not visible, pressing the LINE SEL button will display the menu; it will not turn off Line Select mode.*

3. Press the appropriate soft key to select the appropriate field. The selections available depend on input signal standard and format.

4. Turn the GENERAL knob to select the line you want to view.

NOTE. *If other Waveform display tiles are in Field Sweep or Picture mode, the selected line will be highlighted with a cursor. For Picture displays, the cursor is enabled in the **Main > Config > Readouts & Brightups** menu using the **Pix Brightup Line** setting.*

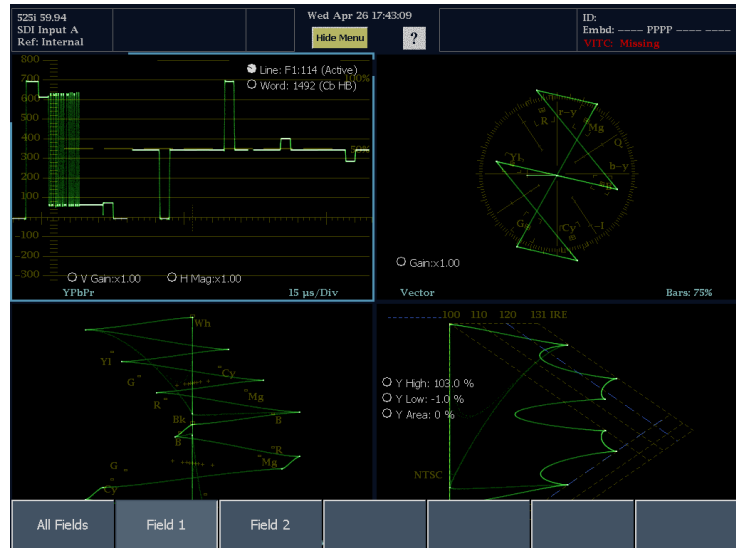

To Adjust Headphone Volume and Source

1. Press the AUDIO button.

NOTE. The headphone icon appears at the bottom of the Audio display. It appears on the left if the Aux Display is off. The headphone icon appears on the right if the Aux display is set to Phase or Surround.

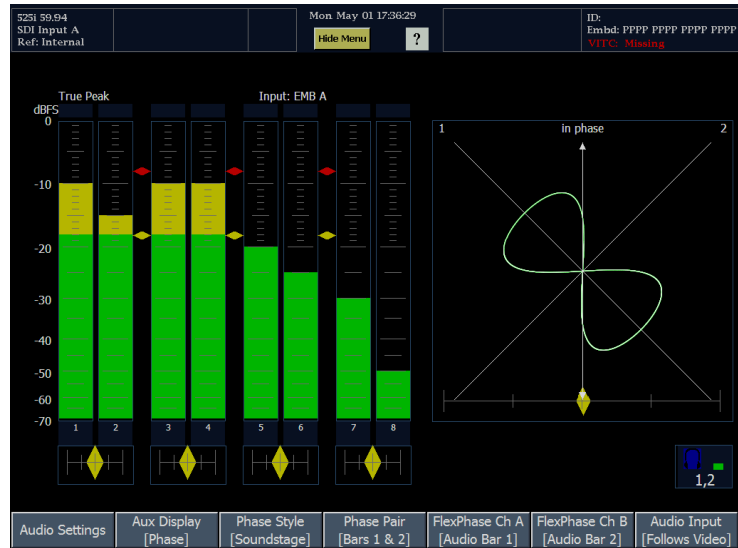

2. Touch the headphone icon.
The headphone icon changes color to yellow when it is selected.



WARNING. To avoid damaging your hearing, before you put on headphones, always turn the volume down to the minimum and then turn it up slowly.



3. Adjust the headphone volume using the large knob.
The color of the headphone bar changes to give an indication of the volume level.
4. To change which meter bars are used as the source for the headphones, touch either meter bar in a pair to select that pair as the source.
5. Touch the headphone icon after you are finished adjusting the volume to disassociate it from the large knob.

To Configure Your Instrument

The Configuration menu is used to change the settings of the waveform monitor that are changed only occasionally or settings that are not specific to a tile, such as printer settings.

To display the Configuration menu:

1. Press the MAIN button to display the Main menu.
2. Touch the Config soft key to display the Configuration menu.

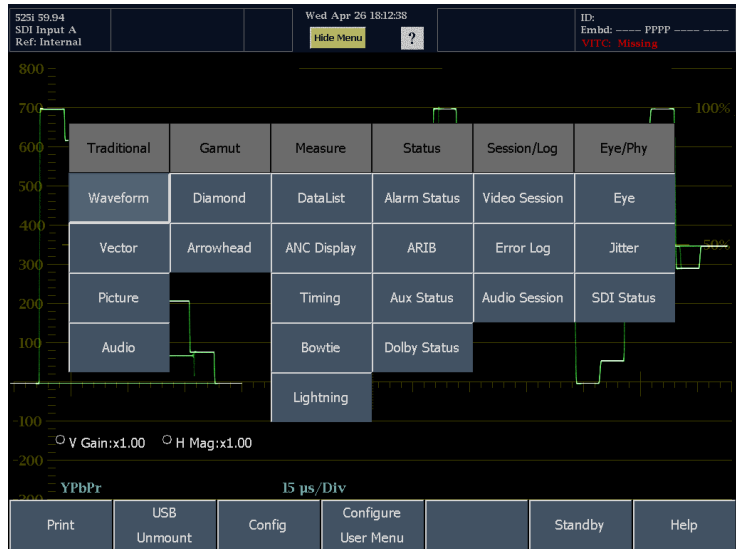

To Select/Adjust a Parameter:

3. Touch the soft key for the parameter you would like to adjust.
4. Adjust parameters as you would any other setting.



The following table lists the parameters that can be set from the Config menu.

Soft key	Description
Diagnostics	Run diagnostic tests and calibration procedures. Calibrate the touch screen. For details on how to run the diagnostic and calibration procedures, see the service manual.
Colors & Intensity	Set colors for trace and graticule and set intensity for elements of the display.
Readouts & Brightups	Enable the display of "brightups" on gamut errors, enable the display of the line select cursor on the Picture display, specify whether Capture applies to all tiles or the selected tile, and define custom Safe Areas.
Closed Caption	Specify closed caption parameters.
Alarm Setup	Specify what type of alarms are monitored and how the alarms are reported.
Utilities	View instrument options and software versions, set time and date, control LCD and front panel button illumination levels, specify network communications parameters, and initiate a system software upgrade.

To Use Online Help

The waveform monitor online help is both a quick reference to instrument operation, and the reference for the details of instrument operation. There are two types of help: the Main menu Help and context-sensitive help. The Main menu Help is accessed from the Main menu by touching the **Help** soft key. The Main menu Help contains task-oriented guides to using the waveform monitor. The context-sensitive Help is accessed by touching the **?** icon in the status bar and then selecting the soft key for which you want help. When the online help is enabled, selecting any soft key on the display will display a help topic. To make changes to instrument settings, you must turn off the context-sensitive help.

To display online help:

1. Display the menu or submenu for which you want to view the online help.
2. Press the **?** in the Status Bar. When Help mode is enabled, the **?** icon changes color to green. If the Help mode is not enabled, the **?** icon is white.

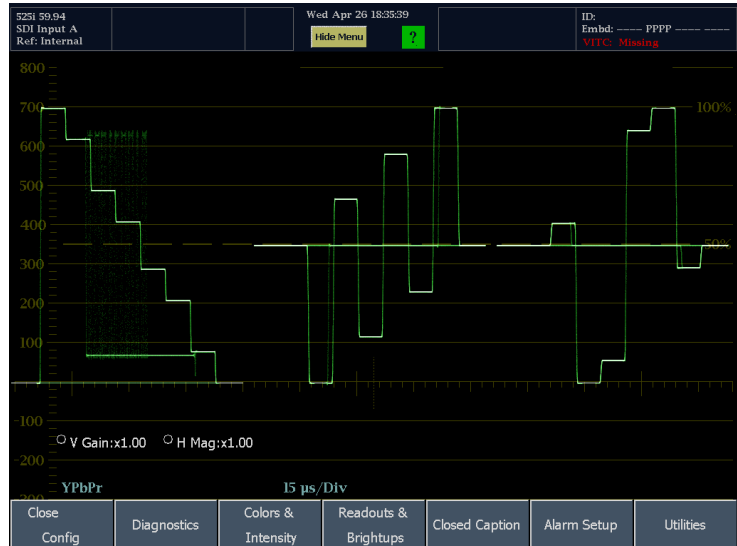

3. Touch any soft key to get help on that soft key.
4. Use the navigation keys at the bottom of the help window to scroll through the help text.
5. Touch Close to remove the Help window.
6. Touch the **?** icon in the Status Bar to turn off the context-sensitive help.

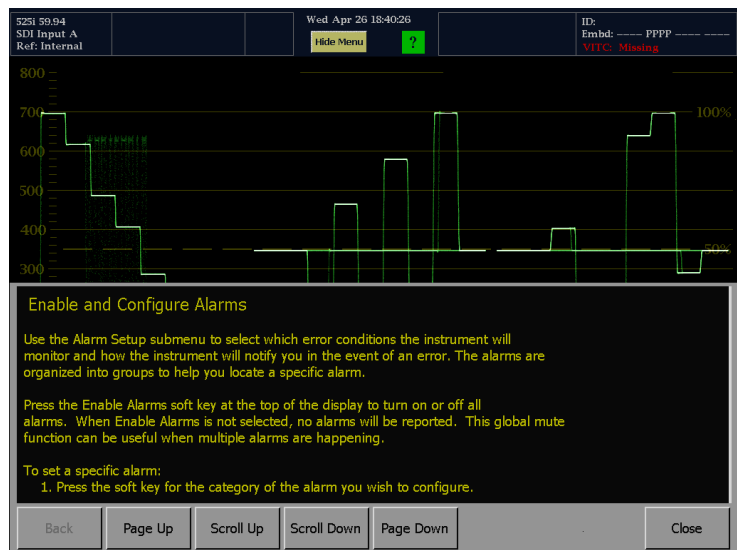

Displaying help when there is no Status Bar displayed is slightly different. Instead of selecting the ? icon, you select the Help soft key.

To display online help when no Status Bar is visible:

1. Touch the Help soft key to enable Help mode.

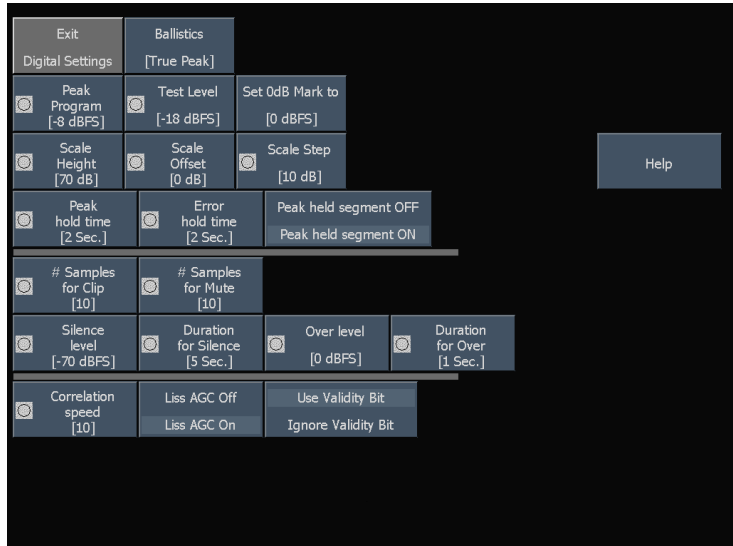

2. Touch any soft key to get help on that soft key.
3. Use the navigation keys at the bottom of the help window to scroll through the help text.
4. Touch Close to close the Help window.
5. Touch the **Press any button to get context sensitive help** soft key to disable Help mode.

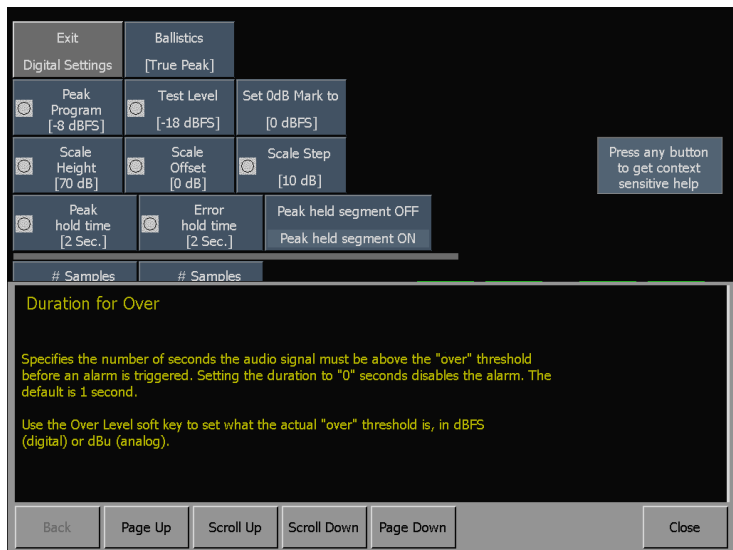

To Connect to a Network

The following topics cover configuring the IP settings, so that you can use the waveform monitor over a network, and configuring SNMP, which is required if you are using commands to control the waveform monitor.

Connection and IP Settings

To allow network access to the instrument, you need set the IP address. Network addresses can be assigned either automatically or manually. If your network does not use DHCP, you will have to manually enter the address for the instrument. To get an address, talk to your LAN administrator.

Set up the monitor as described in the steps that follow.

NOTE. You may want to connect directly between your PC and the WFM7100. (See page 54, To Connect Directly to a PC.)

1. Press the MAIN button to display the Main menu.
2. Touch the **Config** soft key to display the Configuration submenu.

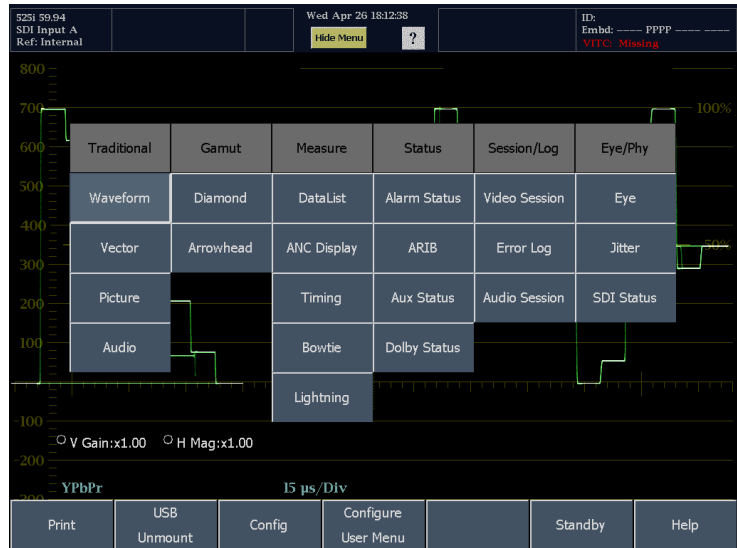

3. Touch the **Utilities** soft key.



4. Touch the **Communications** soft key.



5. Touch the **Config Mode** soft key.

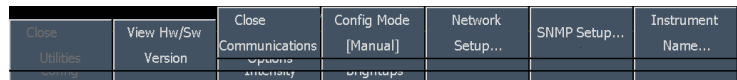

6. Set the Config Mode to **Manual** or **DHCP**, depending on your network setup. Selecting the configuration mode will close the Config Mode submenu.

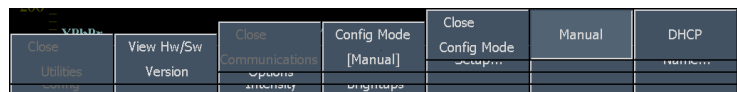

7. Touch the Network Setup soft key.
 - If you plan to control the waveform monitor over the network with SNMP commands, select **Enabled** under **Remote Control Port**.
 - If you plan to access the waveform monitor over the network using a web browser, select **Enabled** under **Remote Web Interface**.
8. If you can't use DHCP, you will have to set the IP Address, subnet mask and gateway address network parameters in the Network Setup menu; see your LAN administrator for the required values. (Be sure to use compatible addresses between the PC and the monitor.)
9. If you will use SNMP commands with the waveform monitor, touch the SNMP Setup soft key.

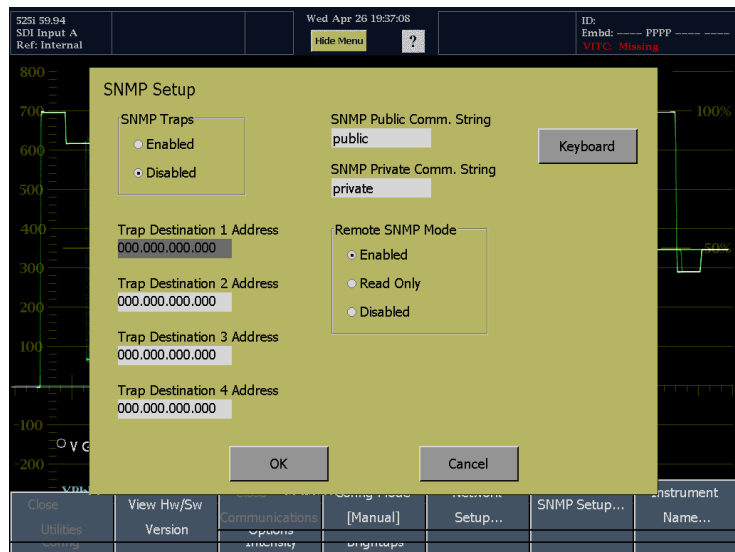
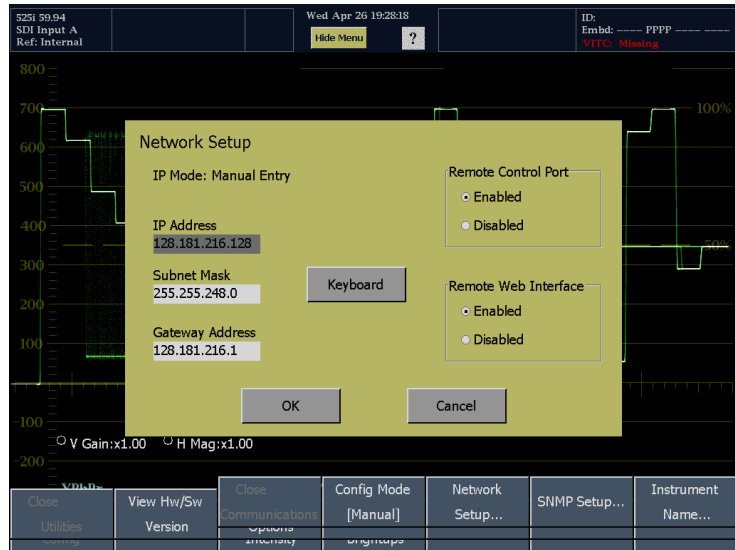

Change the settings based on your requirements:

- **SNMP Traps:** This setting allows you to turn on or off the capability of the waveform monitor to generate SNMP traps.
- **SNMP Public Comm. String:** This setting specifies the string that SNMP commands must include to have read-only access. The default public community string is "public". If you enter a new string, the waveform monitor will strip any leading or trailing spaces in the string: for example, " my stuff " will become "my stuff". The public community string cannot be blank. If you input a blank string, the instrument will set it to the default string.
- **SNMP Private Comm. String:** This setting specifies the string that SNMP commands must include to have read/write access. The default private community string is "private". If you enter a new string, the waveform monitor will strip any leading or trailing spaces in the string: for example, " my stuff " will become "my stuff". The private community string cannot be blank. If you input a blank string, the instrument will set it to the default string.
- **Trap Destination 1–4 Address:** These settings allow you to set IP addresses to which SNMP traps are sent.

Remote SNMP Mode: This setting enables you to allow or deny remote control access to the waveform monitor over a network. You can still access the waveform monitor using the Web Interface when this setting is Disabled, but you will not be able to view or change instrument settings using SNMP management software. If this setting is Read Only, you can view instrument settings but not change them. If this setting is Enabled, you can view and change instrument settings using SNMP management software.

10. Press the **Close** soft keys to close the submenu.

To Connect Directly to a PC

A common configuration is to connect the monitor directly to a PC.

1. Connect your waveform monitor to a PC through a HUB as shown (the actual IP addresses will depend on your network). A standard Cross-Over cable can be substituted for the HUB.
2. Set up the monitor as though you are going to connect to a network. (See page 51, *To Connect to a Network*.) Choose Manual IP mode and set the IP address manually. Be sure to set an address that is compatible with the setting of your PC.
3. Configure the SNMP setup, if used. (See page 51, *To Connect to a Network*.)

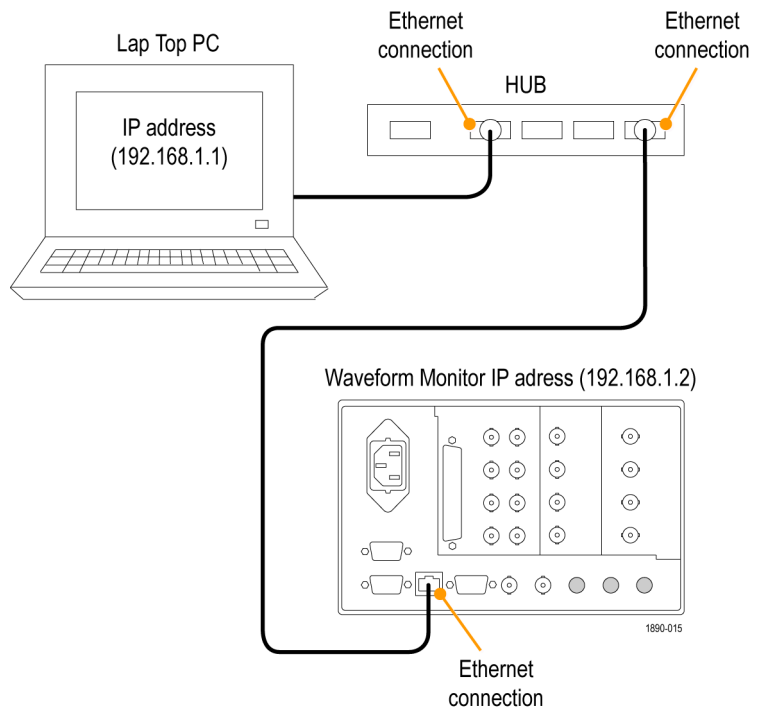

To Print Screens and Event Logs

The waveform monitor can print screens and event logs to printers connected by a USB cable.

1. Connect your printer to the USB port on the front panel.
2. If you want to print a screen, set up the monitor display as you want to print it. (No setup is required to print an event log.)

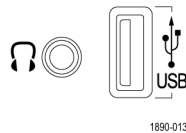

3. Press the MAIN button to display the Main menu.

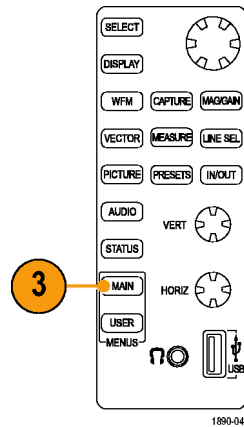

4. Touch the **Print** soft key.

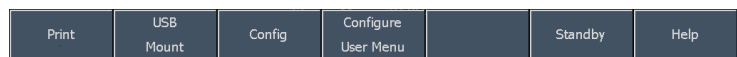

5. Touch the **Print What** soft key and select what you want to print.

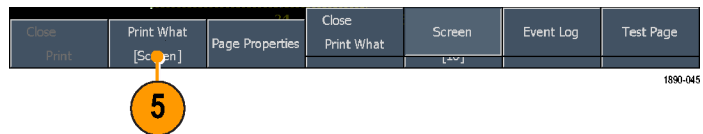

6. Touch the **Page Properties** soft key and set the page properties as required.

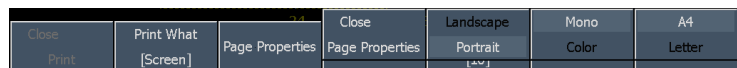

7. If you are printing an error log, you may want to limit the number of pages printed (error logs can be long). Select the **Page Limit** soft key and chose a page limit.

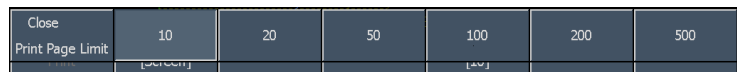

8. Touch **Select Printer** and chose which printer you will use.

See the following procedure *Creating a Printer* for instructions on how to add a printer to the list.

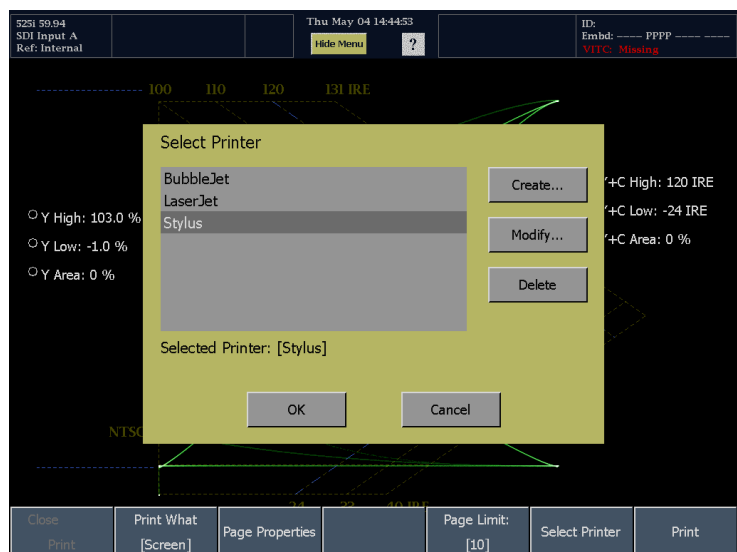

9. Touch the **Print** soft key to print the selected item.



Creating a Printer

Before you can print anything, you must create a printer for the Select Printer dialog. To create a printer:

1. Press the MAIN button to display the Main menu.

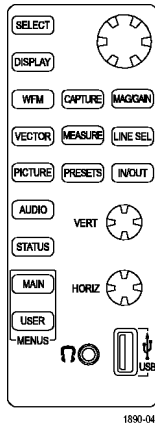

2. Touch the Print soft key to display the Print submenu.

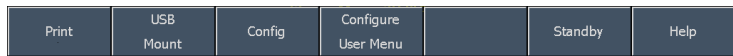

3. Touch **Select Printer** to display the Select Printer dialog box.

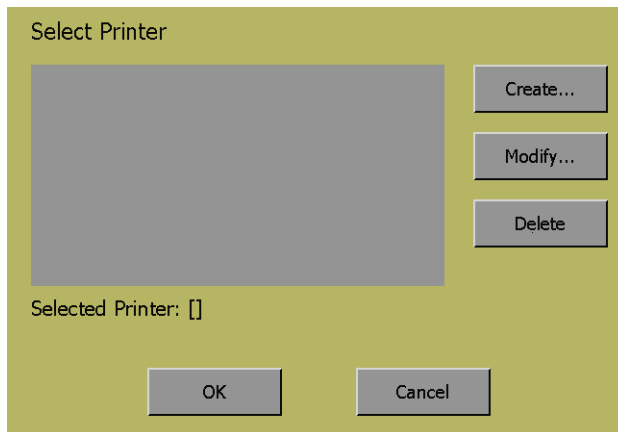

4. Touch the **Create...** soft key to add a printer to the list.
5. Scroll through the Printer Make and Model listing to select an appropriate printer.
6. Select a USB Device identifier. Use different identifiers for different printers.

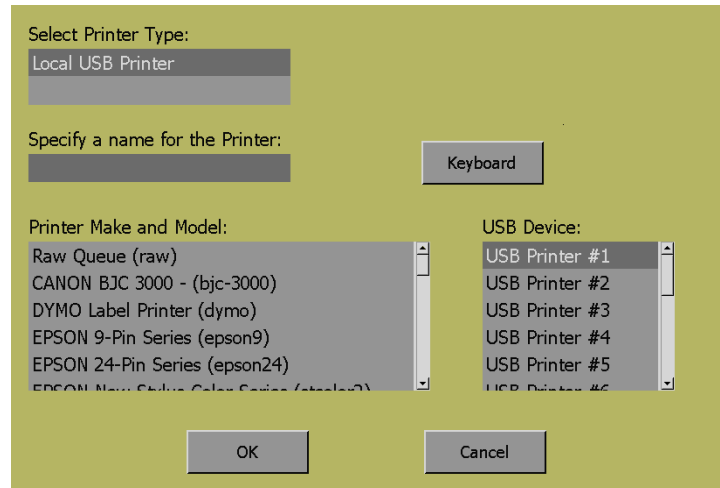

7. Touch the **Keyboard** soft keys to enter a name for the new printer, and then touch **Return**.



8. Touch **OK** to save the configuration.

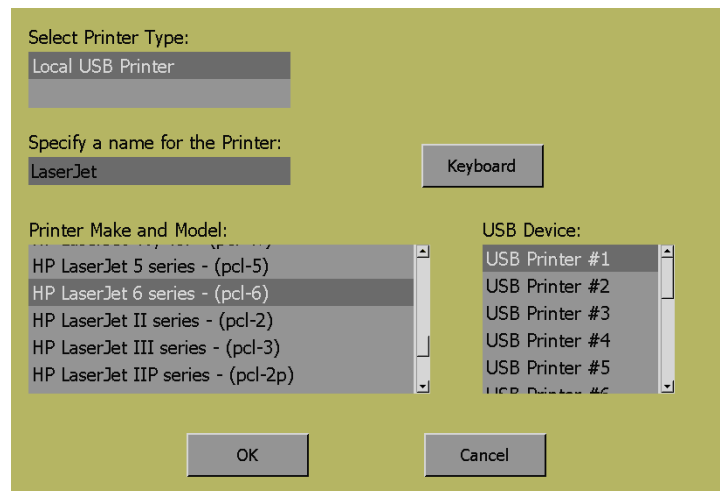

To Create a User Menu

The waveform monitor enables you to create a user-defined menu for your requirements. The MyMenu custom menu saves you time by placing frequently used controls on an easily accessed menu.

To create a User menu:

1. Press the **MAIN** button to enter the Main menu.
2. Select **Configure User Menu**.

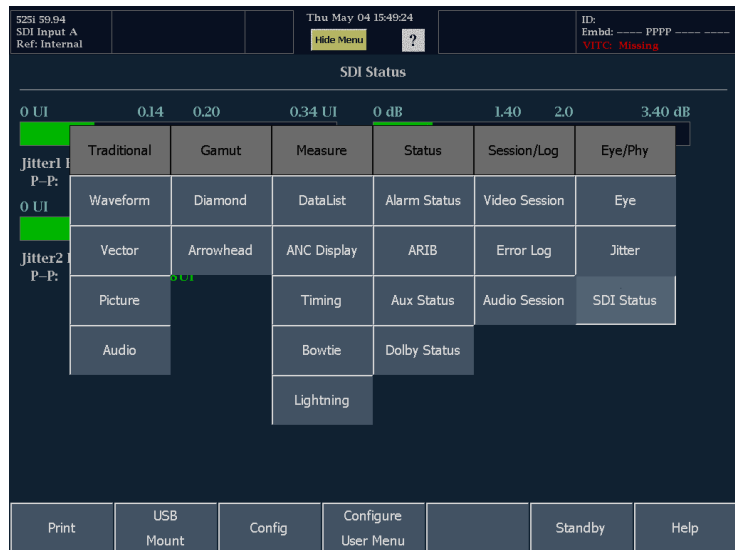

3. Select **Conf User On** from the menu. A check mark will appear in the check box when the function is enabled.
4. Touch **OK** to begin configuring your custom menu.

NOTE. The menu configuration process will display a series of instructions to guide you through the process of creating your menu.

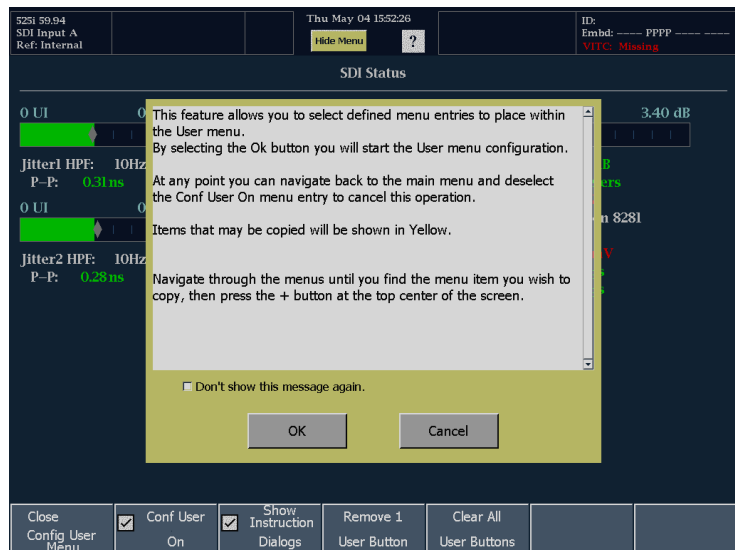

Once Config User is enabled, a + icon appears in the Status Bar. Only yellow-colored soft keys can be added to your custom menu.

- To add a soft key to your custom menu, touch the + icon. The + icon will change color to blue.

Once the + icon is blue, the next yellow soft key you touch will be added to your User menu.

For example, if you wanted to add the Diamond display to your User menu (since it is not available from the front panel) you would touch the Diamond soft key.

If the soft key you want to add to your User menu is not currently visible, you must navigate to the menu where the soft key is located, and then touch the + icon to add the soft key to the User menu.



6. Once you touch a soft key that you want in your User menu, the waveform monitor displays the current custom menu. To add your selection to the User menu, touch one of the soft keys (selecting an existing soft key will overwrite it). The item you add will be placed at the location of the soft key you touch. Once the item has been added to the User menu, the Main menu is displayed.
7. To exit the Configure User menu mode, select **Configure User Menu** from the Main menu, and clear **Conf User On**.



8. To display your custom menu, press **CUSTOM** on the front panel.
9. Once you have completed your User menu, save it in a Preset.



CAUTION. User menus are saved as part of a Preset. Therefore, if you recall a Preset, your existing User menu will be overwritten by the recalled Preset. Even if the recalled Preset does not have a User menu, the existing User menu will be overwritten.



Usage Notes

Until you press the + icon (so it is colored blue), touching a soft key may or may not initiate an action. For example, if the Main menu is displayed, touching the Audio soft key will display the Audio menu. From the Audio menu, touching Audio Settings will display the Audio Settings submenu. But, touching several of the soft keys in the Audio Settings submenu will not display a lower level submenu (though some will). This indicates that you cannot select anything below that level.

You do not have to remove a soft key from the User menu to replace it. If you select an existing soft key in the custom menu, it will be overwritten by the soft key you add.

The first time you create a custom menu, instruction dialogs will appear to explain how to create a User menu. You can turn off the instructions by checking the **Don't show this message again** checkbox in the dialog. You can also turn off the instructions (and turn them back on) using the **Show Instruction Dialogs** soft key in the Configure User Menu submenu.

You can remove a single button from the User menu by using the **Remove 1 User Button** soft key in the Configure User Menu submenu. You can remove all buttons from the User menu by using the **Remove 1 User Button** soft key in the Configure User Menu submenu.

Waveform Display

The WFM button displays the Waveform (WFM) display, which is the familiar voltage versus time display used to view a waveform. You can view the input signal in line or field sweep. You can choose the mode in which SDI signal elements are displayed (RGB, YRGB, or YPbPr), and you can apply filters to the signal. You can also display an SDI input as though it were a composite signal. You can also control whether EAV and SAV is included in the display in the Settings submenu.

Waveform Display Elements:

1. Is colored white when vertical gain is X1; otherwise yellow color indicates V Gain is x2 or greater, or set to variable.
2. Is colored white when Horiz. Mag. is X1; otherwise yellow color indicates H Mag is x10 or greater, or set to Best View.
3. Lists the currently displayed waveform color-space. Dashes (--) indicate components not displayed.
4. List the current sweep rate for tile.
5. Lists the currently selected field and line (when in Line Select mode).

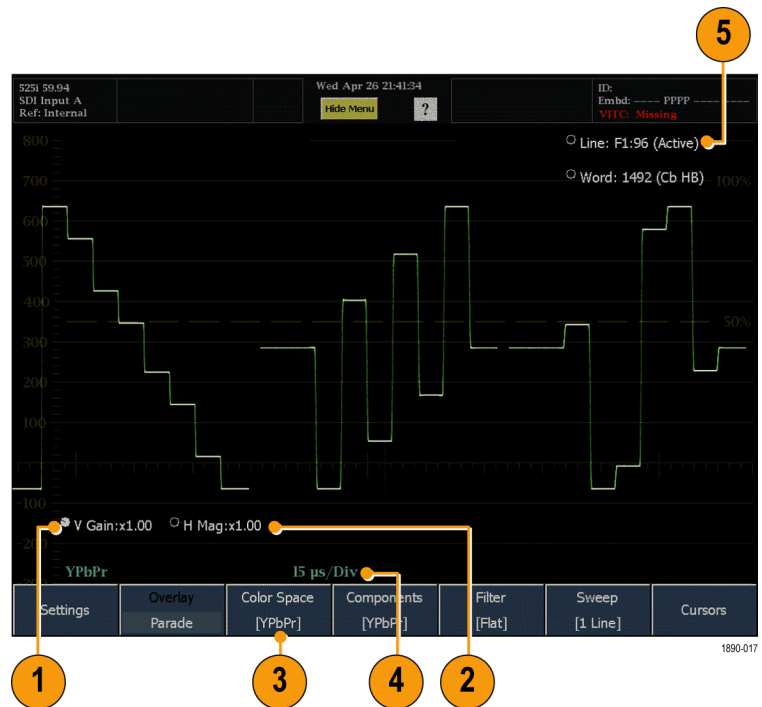

Waveform Menu and Settings

The Waveform menu enables you to choose the display style and display mode used in the active tile (SDI inputs only), select a filter to apply to the input signal, and set the sweep mode.

To display the Waveform menu:

- Press **WFM** on the front panel.

To specify the color space used to display the signal, use the Color Space menu to select among the following the choices (only available while displaying SDI inputs) :

- **YPbPr** - Displays the input as Luminance (Y) and color difference (Pb, Pr) components.
- **YRGB** - Displays the input as Luminance (Y), Red (R), Green (G), and Blue (B) components.
- **RGB** - Displays the input as Red (R), Green (G), and Blue (B) components.
- **SDI -> Composite** - Displays the SDI input as if it has been encoded into composite. The sync and burst in this mode are synthetic and convey no information about signal quality.

When viewing 525-line SDI input as a composite waveform while using line select mode, both burst phases may appear when you would expect to see only one. This is because the line selection in SDI Mode is an odd/even selection, while composite signals are normally viewed with a one-of-four or one-of-eight line selection.

To choose how the signal components are displayed in the active tile, use the display mode setting to select:

- **Parade** - has all the components shown one beside the other like cars in a parade.
- **Overlay** - has all the components drawn at the same location so that they appear one on top of the other.

The Waveform menu **Filter** selection allows you to select filters to be applied to SDI video signals. This is useful to isolate a specific characteristic of the input. For example, to measure amplitude, you may want to use a Low pass filter to remove the high frequency components.

To choose a filter, select one of the following filters from the Filter menu:

- **Flat** - Display with the full available bandwidth.
- **Low Pass** - Display only the low-frequency portion of the signal.

The **Components** submenu allows you to select filters to be applied to Composite video signals. This is useful to isolate a specific characteristic of the input. For example, to measure amplitude, you may want to use a Luma or Low pass filter to remove the high frequency components.

To choose a filter, select one of the following filters from the Filter submenu:

- **Flat** - Display with the full available bandwidth.
- **Luma** - Display only the low-frequency portion of the signal.
- **Chroma** - Display only the portion of the signal with frequencies near the color subcarrier. For Composite inputs only.

The Sweep soft key is used to specify whether lines or fields are shown in the Waveform display. To set the sweep, select on of the following choices from the Sweeps submenu:

- **1 Line** - One horizontal line is displayed. Use the Line Select function to choose one line out of a field or frame.
- **2 Line** - (Overlay layout mode only) Two consecutive horizontal lines are displayed.
- **1 Field** - All lines for one video field are displayed.
- **2 Field** - (Overlay layout mode only) All lines for two video fields are displayed.

Vector Display

The VECTOR button calls up the Vector display, which provides plots of the R-Y and B-Y color signals.

Display Elements for SDI Inputs:

1. **Line.** When LINE SEL is enabled, touch to select the line being viewed.
2. **Gain: x1.00** Touch to select and use the knob to adjust the Gain setting.

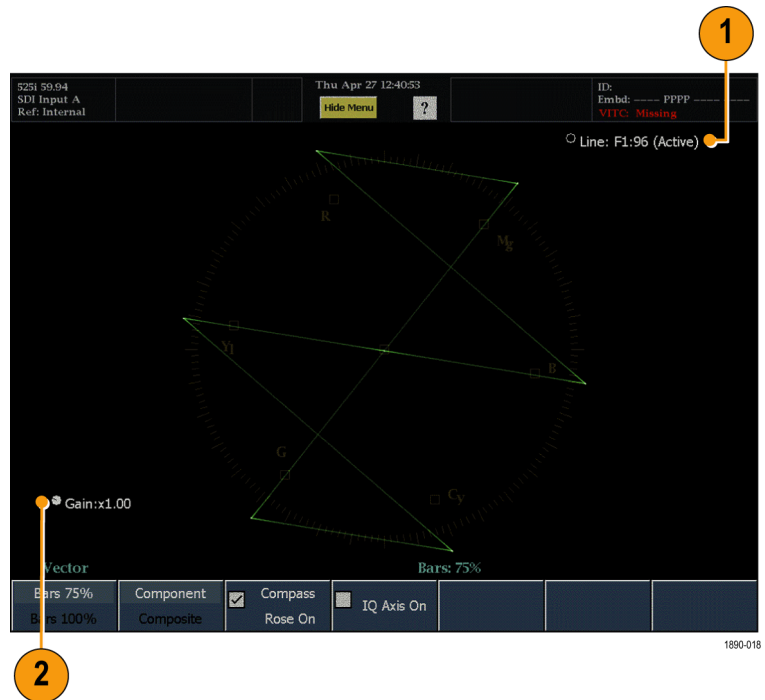

Display Elements for Composite Inputs:

1. **Line.** When LINE SEL is enabled, touch the readout to select and use the knob to select line being viewed.
2. **Gain: x1.00** Touch to select and use the knob to adjust the Gain setting.
3. **Phase.** Touch to select and use the knob to adjust the Phase setting.

NOTE. You can toggle between adjusting the Phase and Gain by pressing the SELECT button.

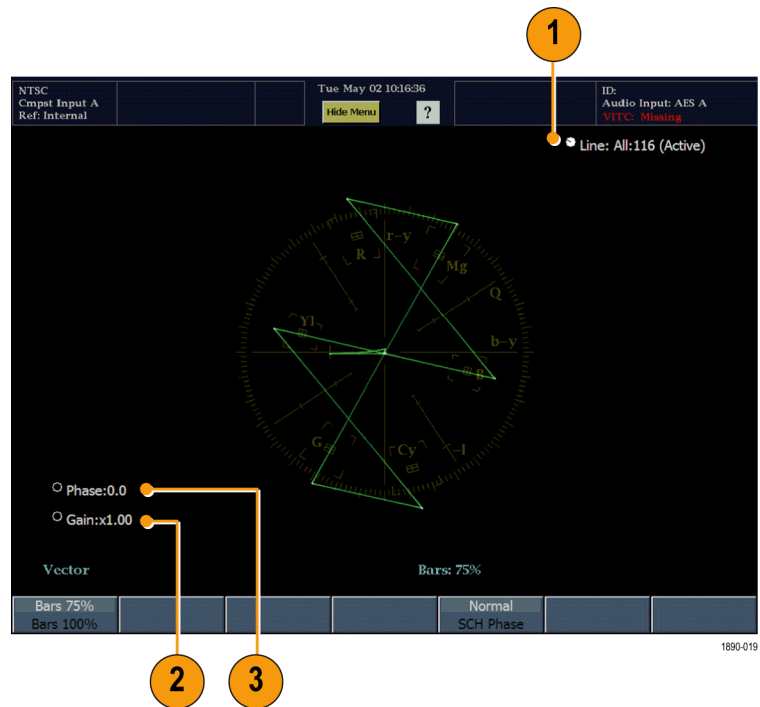

Vector Menu

The Vector menu enables you to specify a number of display parameters.

Elements of the menu for SDI input signals:

- **IQ Axis On.** When checked, adds graticule lines in Component Vector mode for the I axis and the Q axis.
- **Compass Rose On.** When checked, adds the compass rose graticule for component signals in the Vector mode display.
- **Component/Composite.** Toggles the vector scaling and graticules between the Component and Composite signal representations.
- **Bar Target Setting.** The bar target setting, either 75% or 100%.

Elements of the Vector menu for Composite input signals:

- **Normal / SCH Phase.** Selecting SCH Phase adds one or more radial traces to the vector display that correspond to the phase of a subcarrier that is synchronous with the horizontal sync pulse.
- **Phase: Normal / Phase: +V** Present only on Vector displays with PAL input format. The Phase Normal mode shows both phases of the vector that results from the phase alternating on lines (PAL). The Phase + mode inverts the phase on every other line to "undo" the PAL sequence and thus shows all lines in one phase orientation.
- **Bar Target Setting.** The bar target setting, either 75% or 100%.

Picture Display

Pressing the PICTURE button calls up the Picture display, which lets you see the picture generated by the video signal. You can choose to display the picture with or without a frame.

Display Characteristics:

- In full-screen mode (shown), there is no cropping.
- In Active-picture mode, pictures are decimated horizontally or vertically to achieve the correct aspect ratio. This decimation may cause some artifacts. This behavior may be evident on a sweep or convergence signal.
- Also see the online help for the Active Picture / Full Frame for related information.

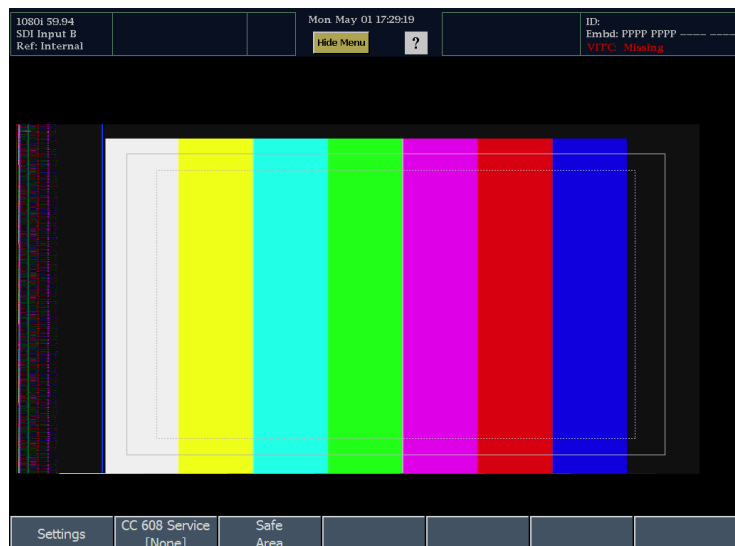

Picture Menu

The Picture menu enables you to specify the closed caption service type and set safe areas. From the Settings submenu, you can set the aspect ratio (SD only) and choose whether to display only the active picture portion of the signal or the full-frame picture. With Active Picture selected, only the active video portion of the signal is displayed and the aspect ratio is correct. With Full Frame selected, elements of the signal outside the active video are visible (for SDI signals). When full frame is selected, you can see user data, embedded audio, and elements in the vertical interval.

To display the Picture menu, press the **PICTURE** button on the front panel.

NOTE. You can see signal elements outside the active video only when the PICTURE display is set to FULL (SDI inputs only). You will not be able to see sync signal elements on Composite signals.

Audio Display

Pressing the AUDIO button brings up the Audio Display. The Audio display provides level meters and a phase or surround display for monitoring audio signals. The Audio display always shows the level meters and correlation meters. When you choose to display the Aux Display, you can choose to display a Phase display (also known as Lissajous) or a Surround display. The left portion of the Audio tile displays the level meters and the right portion shows the Phase or Surround display.

You must have one of the following options installed to monitor audio signals:

- Option DS: monitors digital audio, both embedded and AES/EBU inputs.
- Option AD: monitors analog audio formats and all the digital audio formats included in Option DS.
- Option DD: monitors and decodes Dolby Digital audio (AC-3) plus the analog and digital audio formats included in Option AD.
- Option DDE: monitors and decodes Dolby E plus all the audio formats included in Option DD.

Display Elements

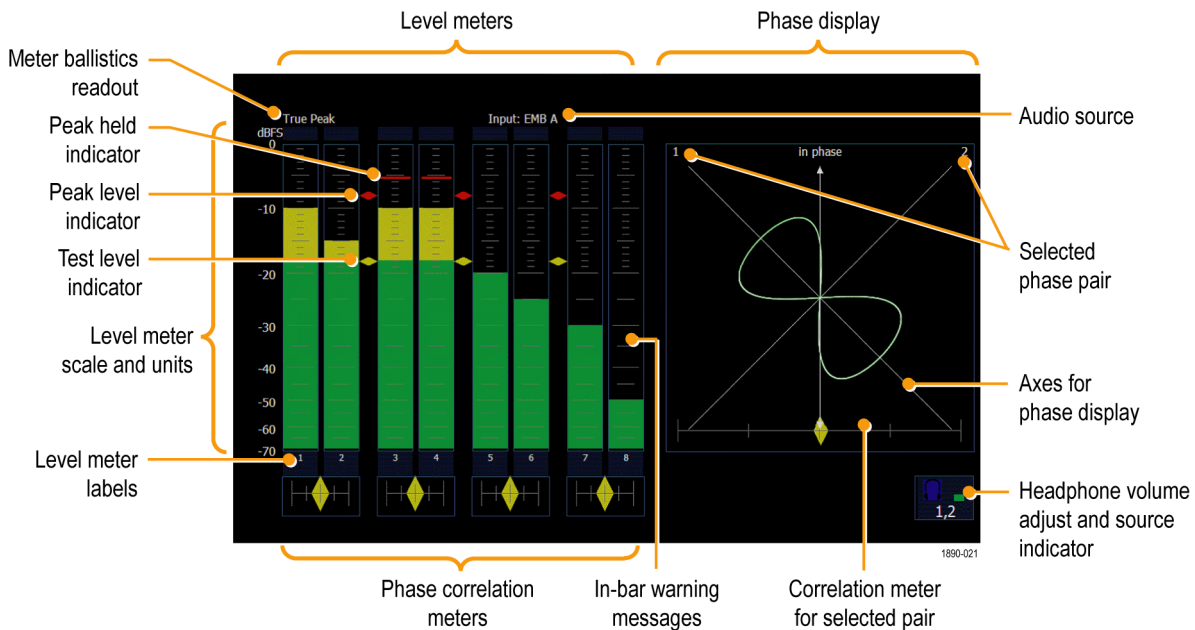

Element Descriptions

Element	Description
Level meters	Indicate the amplitude of selected audio channels.
Aux Display	Shows either a plot of one channel versus the other in a pair or plot of surround channels.
Audio source	The selected audio input.
Level meter labels	Identifies the signal in each meter bar.
Level meter ballistics readouts	Displays the selected dynamic response characteristic.
Axes for phase display	Shows the orientation of the two audio signals.
Phase correlation meters	Displays phase correlation between the two channels of each appropriate pair. Located under the bars for the same channels. Duplicated under the Phase display. Has configuration response time.
Test level and Peak program level indicators	Diamond-shaped markers between the level bars that indicate the configurable limits set up for the display. Above the Test level the bar displays in a yellow color. Above the Peak level the bar displays in a Red color. Test level is also known as Reference level or Line-up level.

Element	Description
Level meter scale and units	By default, the zero dB mark is at digital full scale, and units are in dB relative to full scale (dBFS). You may also set the 0 dB mark to either the Peak Program level or the Test level.

Above-bar Warning Messages

The waveform monitor displays warning messages above the level meter bars. The warning messages that can appear above the bars are shown below.

CLIP. The number of consecutive samples is at or exceeds the # Samples for Clip setting.

OVER. The signal has been at or above the specified Over Level for a time exceeding the Duration for Over setting.

In-bar Warning Messages

The waveform monitor displays warning messages within the level meter bars. The warning messages that can appear are shown below in order of priority.

UNLOCKED. The instrument is not locked to an incoming signal on the indicated input channel. Data cannot be decoded and all data and other errors are ignored. This means that if an AES input is selected, nothing recognizable is present on the input, or if embedded audio is selected, the VIDEO input is unrecognizable.

AES PARITY. The incoming subframe does not have even parity as specified by the digital audio standards. The data sample is unreliable and is ignored. The level meters and Lissajous display treat the sample as a zero sample.

AES CRC ERROR. The CRC code in the AES channel status packet is incorrect. Sometimes the CRC code is set to zero, indicating that the signal is missing; when this is the case, this message is not displayed.

MUTE. The number of consecutive all-zero samples is at or exceed the # Samples for Mute setting.

SILENCE. The signal has been at or below the specified Silence Level for a time exceeding the Duration for Silence setting.

DISABLED. Disabled can appear for three reasons:

- Analog audio is selected as the bar source, which causes bars 7 and 8 to display “DISABLED” because there are only 6 analog inputs.
- Embedded audio is selected as the bar source when Composite video is selected as the video input. There is no embedded audio in composite, so all of the bars will display “DISABLED.”
- If the currently selected audio source’s Bar to Input Map does not have all of the bars mapped to inputs, any bars that are unmapped will display “DISABLED.”

AES V BIT. Indicates that the Validity bit is set high for one or more data samples. In the AES/EBU standard, a set validity bit indicates that the sample is not suitable for conversion to audio. By default, the level meter bars and Lissajous display treat the affected samples as zero samples.

Audio Menu

The Audio menu enables you to select the audio input source and specify whether or not the signal phase is displayed (Aux Display). If the signal phase is displayed, you can also specify the style of the phase display and the pair of inputs that is shown in the phase display.

To display the Audio:

- Press the **AUDIO** button to display the menu.

To select the source for the Audio display, select **Audio Input** in the menu and select a source. The number of available sources depends on which audio option is installed. Choosing any given input will make that audio the monitored signal regardless of which video input is active. Alternatively, you can choose **Follows video** to enable the mapping that allows changing the audio source as the video input selection is changed.

NOTE. Use the Audio Settings menu to select the mapping of input to bar, the meter type, and the Follows video mapping of audio to video.

The Audio menu also provides two pictorial displays that allow you to monitor the signal. Audio phase displays include phase correlation meters, a flexible Lissajous display (for any pair of channels), and a multiple-channel "Surround Sound" display that shows audio levels (weighted or un-weighted), total sound volume, phantom source locations, and the dominant sound position.

To add a phase display to the audio tile, select **Aux Display** in the Audio menu. From the Aux Display submenu, you select whether a phase display is shown or not.

To choose the format of the Aux Display, select between the following two entries in the submenu:

- **Phase:** The Phase display is a plot of one channel against another on an orthogonal pair of axes. The Phase display can be displayed in two styles: Soundstage style which plots the two channels at 45 degree angles, with the mono combination appearing on the vertical axis-like a left-right image in a studio and X-Y style which plots left-channel data on the vertical axis and right channel data on the horizontal axis, emulating the X-Y display of an oscilloscope.
- **Surround:** The Surround display enables you to monitor relative loudness of the individual elements rendered in a surround-sound listening environment. (See page 120, *Surround Display Elements*.)

To choose the pair of inputs that is displayed in the Phase display, select **Phase Pair** and select which meter bar pair you want displayed in the Phase display. If you select **Bars Flexible Pair** for the Phase Pair, you can use the **FlexPhase Ch A** and **FlexPhase B** soft keys to specify any combination of meter bars to be displayed in the Phase display.

Lightning Display

Pressing the **MAIN** button calls up the Main pop-up menu. From the Main pop-up menu, you can select the **Lightning** display under the **Measure** heading. The Lightning display is a measurement method that allows for the evaluation of the luma signal gain and for making chroma/luma gain comparisons. It can also provide simple indication of inter-channel timing errors indicated by a bowing in the trace between the green-magenta transition. The display is created by plotting luminance versus B-Y in the upper half of the display and inverted luminance versus R-Y in the lower half of the display. The bright dot in the center of the screen is the luminance blanking level. The points above and below this show the plots of the different color components based on their signal amplitude. The Lightning display requires a color bar test signal be used. However, since most programs have leaders of color bars for setup, you can use the Lightning display to check a program during the leader section.

Display Elements:

1. **V Gain:** The vertical gain.
2. **H Gain:** Horizontal Gain
3. **Line:** The line selected for display. Appears only in Line Select mode.

NOTE. To change the settings for either Vertical or Horizontal gain, touch the gain readouts and then adjust their values using the large knob.

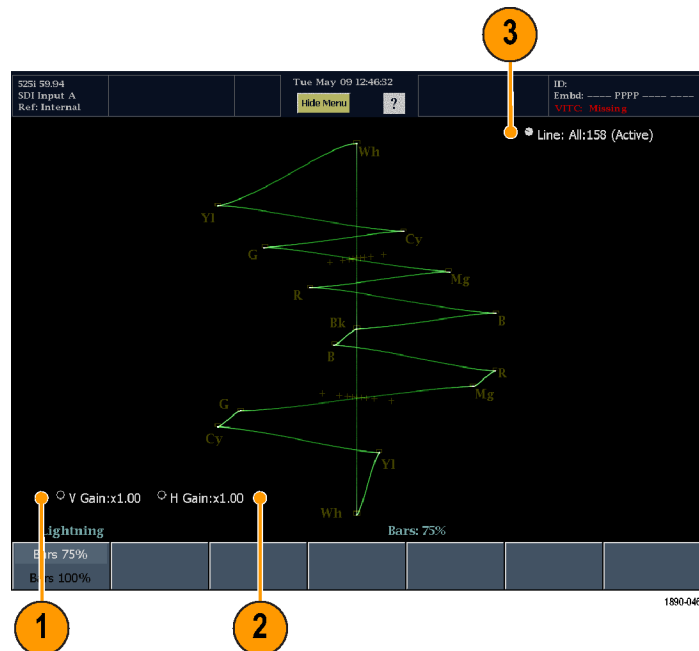

Lightning Menu

The Lightning menu allows you to set the bar targets to either 75% or 100%.

Diamond Display

Pressing the MAIN button calls up the Main pop-up menu. From the Main pop-up menu, you can select the Diamond display under the Gamut heading. The Diamond display shows Gamut violations of the SDI input if translated to RGB color space.

Display Elements:

1. **High threshold:** Shows the level above which RGB components are considered too large and out of gamut. Signals above this level will trigger an error/alarm if the number of pixels in error exceeds the Area setting.
2. **Low threshold:** Shows the level below which RGB components are considered too small and out of gamut. Signals below this level will trigger an error/alarm if the number of pixels in error exceeds the Area setting.
3. **Area** - Specifies the percentage of the total image pixels (up to 10%) that can be outside the current gamut limits, yet not be reported as a gamut error.
4. **Threshold indicators:** indicates the threshold settings using blue dashed lines.

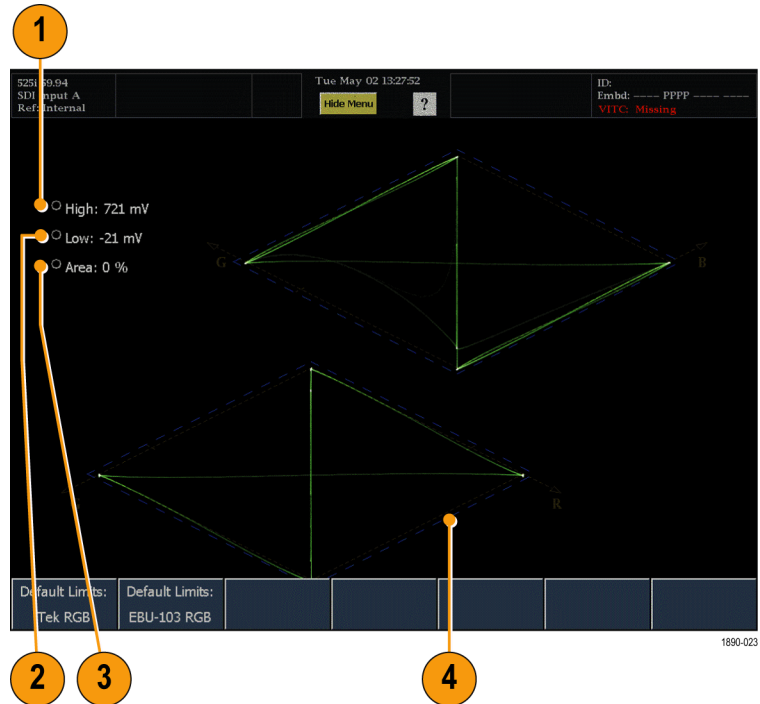

NOTE. To change the threshold settings, touch the threshold readouts and then adjust their values using the large knob.

If the signal appears outside the boundary shown by the blue dashed lines, then the signal is violating the limits that are set. If alarms have been enabled, then gamut violations will be reported when the signals falls outside the boundaries shown by the blue lines if the number of pixels in error exceeds the Area threshold.

Diamond Menu

The Diamond menu enables you to reset the threshold limits to two default settings.

Default Limits: Tek RGB. Resets limits to factory defaults.

Default Limits: EBU-103 RGB. Resets the limit thresholds to the values recommended in the EBU R103--2000 specification.

Arrowhead Display

Pressing the **MAIN** button calls up the Main pop-up menu. From the Main pop-up menu, you can select the Arrowhead display under the Gamut heading. The Arrowhead display is used to show out-of-gamut conditions in composite color space, without requiring a composite encoder. The Arrowhead display plots luma on the vertical axis, with blanking at the lower-left corner of the arrow. The magnitude of the chroma subcarrier at each luma level is plotted on the horizontal axis, with zero subcarrier at the left edge of the arrow. The upper sloping line forms a graticule indicating total luma + subcarrier amplitudes. The lower sloping graticule indicates luma+subcarrier extending toward sync tip (maximum transmitter power).

Display Elements:

- Y High threshold:** Shows the level above which the Luminance value is considered too large and out of gamut. Signals above this level will trigger an error/alarm if the number of pixels in error exceeds the Y Area setting.
- Y Low threshold:** Shows the level below which the Luminance value is considered too small and out of gamut. Signals below this level will trigger an error/alarm if the number of pixels in error exceeds the Y Area setting.
- Y Area** - Specifies the percentage of the total image pixels (up to 10%) that can be outside the current Luma limits, yet not be reported as an error.
- Y + C High threshold:** Shows the level above which the Luma + Chroma value is considered too large and out of gamut. Signals above this level will trigger an error/alarm if the number of pixels in error exceeds the Y + C Area setting.
- Y + C Low threshold:** Shows the level below which the Luma + Chroma value is considered too small and out of gamut. Signals below this level will trigger an error/alarm if the number of pixels in error exceeds the Y + C Area setting.
- Y + C Area** - Specifies the percentage of the total image pixels (up to 10%) that can be outside the current gamut limits, yet not be reported as an error.
- Threshold indicators:** indicates the threshold settings using blue dashed lines.

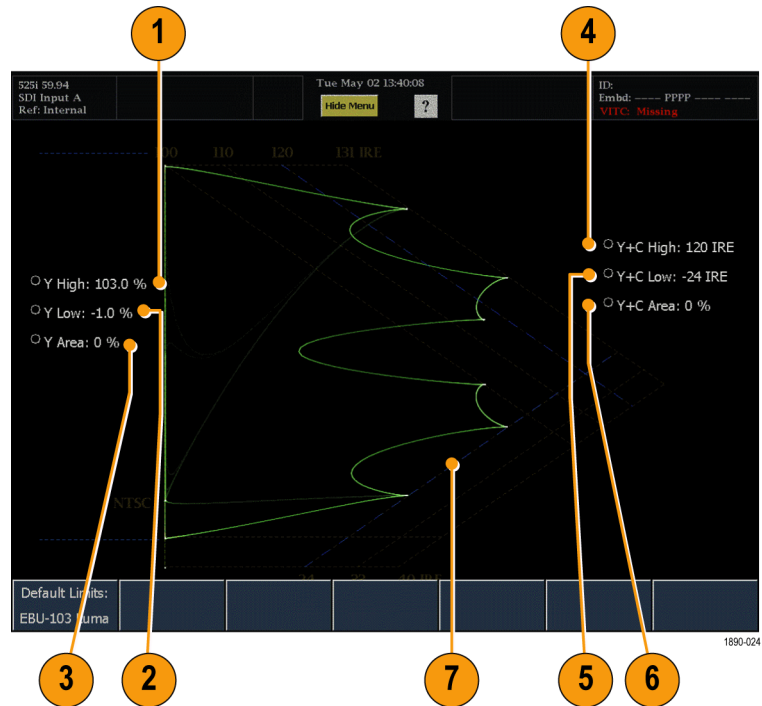

If the signal appears outside the boundary shown by the blue dashed lines, then the signal is violating the limits that are set. If alarms have been enabled, then gamut violations will be reported when the signals falls outside the boundaries shown by the blue lines if the number of pixels in error exceeds the Area threshold.

Arrowhead Menu

The Arrowhead menu enables you to reset the threshold limits to a default setting.

Default Limits: EBU-103 Luma. Resets the luma thresholds to the values recommended in the EBU R103-2000 specification.

NOTE. If you need to reset the Y+C limits to their factory default values, you must perform a factory reset. To do this, press the PRESETS button, touch Settings, touch Recall Preset and select Factory from the Recall menu.

Timing Display

The Timing display is a Tektronix proprietary display that simplifies measuring the timing difference between two signals.

Display Elements:

1. **Input Signal Indicator:** A single ¹ circle representing timing of input signal relative to the reference.
2. **Reference Indicator:** A cross-hair indicator centered in the display represents the reference signal.
3. **Vertical Offset:** The timing difference between the reference and input signal.
4. **Horizontal Offset:** The timing difference between the reference and input signal.
5. **Relative to:** Indicates the chosen zero point for the timing display. ²

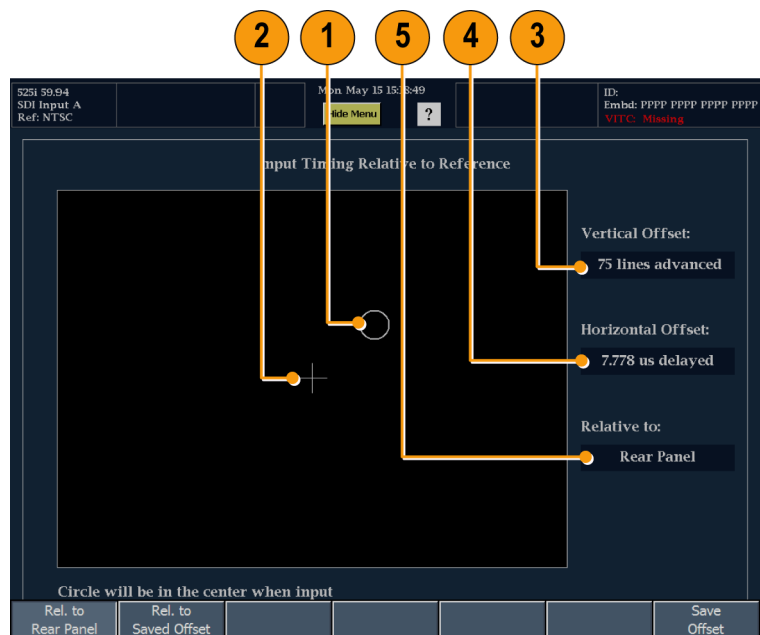

1890-020

¹ More complex timing relationships display multiple circles. (See page 73, *Timing Displays for Simple Versus Complex Timing.*)
² Rear Panel is the default setting, in which offset is shown as zero when the input and reference are at the same timing at the rear panel of the waveform monitor. If you select *Saved Offset*, you can save the timing from one signal, and then display the timing relative to that saved offset.

Timing Menu

The Timing menu enables you to save a timing setting to compare with another signal and specify the zero point of the timing display.

To save the timing of the current input as an offset to the timing display, use the **Save Offset** soft key. The current timing becomes the zero point for the saved offset mode of the timing display. This applies to both the cross-hair target in the middle of the display and the numeric readouts.

NOTE. You cannot save the timing offset if either the input or reference is missing or unlocked. You also cannot save a reference when in internal mode. Saving an offset in these conditions would lead to misleading results so it is not allowed by the instrument.

Save Offset allows you to measure the timing between inputs or to match multiple signals. To select the definition for the zero timing offset, select one of the following:

- **Rel. to Rear Panel** which means that the timing offset will be shown as zero when the two signals are timed down at the rear of the waveform monitor.
- **Rel. to Saved Offset** which means that the timing will be shown as zero offset when the input signal matches the timing of the signal that was present when the offset was saved using the Save Offset menu entry.

This selection changes both the numeric readouts and the target in the middle of the timing display.

Timing Displays for Simple Versus Complex Timing

The number of circles, with each representing a time offset, varies with the complexity of the timing between the reference and input signals. If you are timing input signals with rates that are integer multiples of the reference rates, the instrument can measure the timing deterministically and displays the relationship as one circle (offset) relative crosshair (reference as is shown).

Such cases include timing an NTSC input (multiplier of 1) or a 525 SDI input whose frame time is 33.36 ms (multiplier of 2), against an NTSC reference, which has a frame time of 66.73 ms.

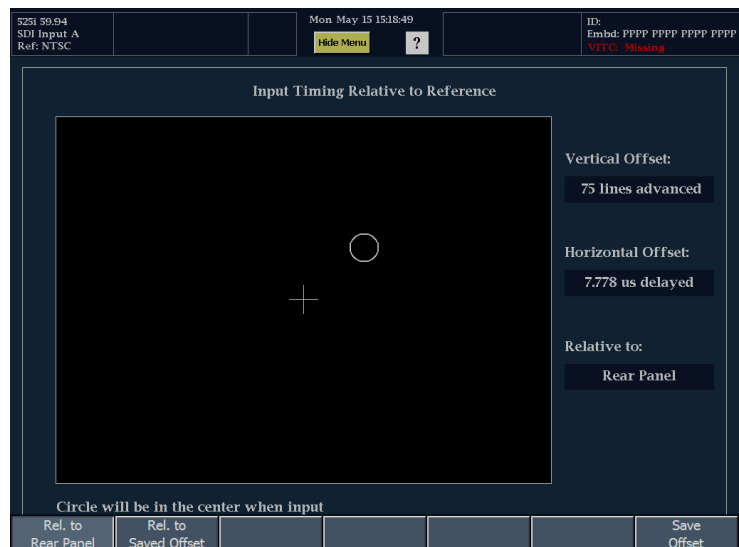

If you time input rates that are not integer multiples of the reference rates, the instrument cannot measure the timing deterministically, so it displays the relationships as several circles. Each circle represents a possible timing offset measurement relative to the reference cross-hair. Display emphasis is given the circle that times closest to zero offset and the numerical readouts track this pair.

Nondeterministic cases include timing of slow rate inputs against fast frame-rate references or when timing video against film rates.

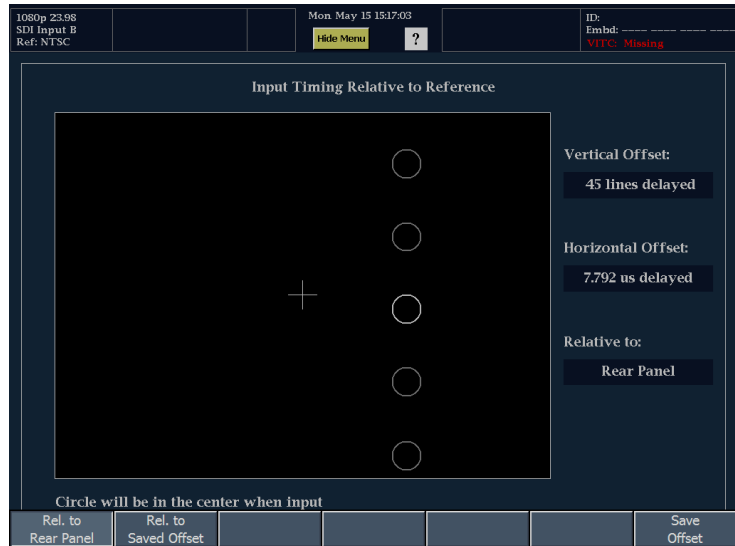

DataList Status Display

Pressing the **MAIN** button calls up the Main pop-up menu. From the Main pop-up menu, you can select the **DataList** display under the **Measure** heading. The Data Display mode shows the actual SD or HD input data without any interpolation. The DataList display shows the signal data in two formats: as a trace and as data. The trace form is shown on the left portion of the display and the data form is shown on the right portion of the display.

Display Elements:

1. **Video / Data:** The waveform monitor provides two modes for representing signal data in the trace portion: Video and Data.
 - **Video Mode:** Shows the data like the video YPbPr display in waveform mode, but without interpolation. The Y, Cb, and Cr traces are offset vertically to separate them, but are aligned temporally. Since Cb and Cr have half the data rate of Y, the samples appear twice as long. Use the Select Channels soft key to turn off individual components of the display.
 - **Data Mode (SD):** Shows the data in the same sequence as it occurs in the serial domain. You see a sample of Y, then of Cb, then of Y' (Y prime), and then of Cr. Then the sequence repeats. The Y sample is the co-sited sample, and the Y' sample is the isolated luma sample.
 - **Data Mode (HD):** Splits the serial data into a Y channel and a multiplexed Cb/Cr channel. The intent is to show the data in the same orientation as it occurs in the serial domain, even though it is displayed as 8 or 10 bit values.
2. **Traces:** In Video mode, you can select which traces to view.
3. **Readout Format:** Select the format of the data readout.
4. **Line / Word:** Touch either readout to use the large knob to select the line or word to be viewed. Press the SELECT knob to toggle control between Line and Word.

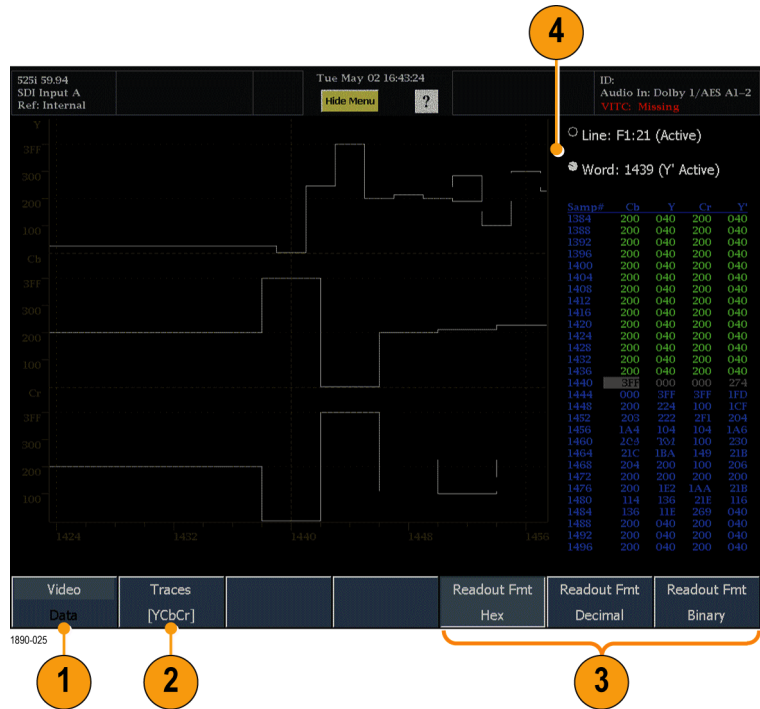

Different fields of the data stream are shown in different colors:

- Green - Active video data.
- Gray - Data in horizontal or vertical blanking intervals.

- White - EAV and SAV packets; other reserved values such as the XYZ word.
- Yellow - Data outside the nominal allowed values.
- Red - Data with illegal values.

ANC Data Display

Pressing the **MAIN** button calls up the Main pop-up menu. From the Main pop-up menu, you can select the **ANC Display** display under the **Measure** heading. The ANC Data Display shows the raw (undecoded) data words in the selected ancillary data packets. The ancillary data is shown only in hexadecimal format. Since the display is updated at approximately two-second intervals, rapid data changes cannot be detected.

Use the large knob and the Select button to enter the DID and/or SDID values for the type of ancillary data packet to be monitored. You can also touch the readouts on the screen to select either DID or SDID for control using the large knob. DID and SDID values have the following characteristics:

- DID and SDID Values range between 0x01 and 0xff.
- For DID values in the range 0x00 -- 0x7F (Type 2 packets), the SDID values are used.
- For DID values in the range 0x80 -- 0xFF (Type 1 packets), there are no SDID values used (the SDID soft key is grayed out).



Status Displays

Status displays are text displays that show signal status. You can view current alarms and errors (those occurring now and within the last few seconds), a history of errors and alarms (up to 10,000 entries), video or audio error statistics, and Dolby audio status. You can display a different Status display type in all four tiles at once. Pressing the STATUS button calls up the last Status display shown in the selected tile and displays the Status menu.

Status Display Types

Alarm Status: Shows the status of all alarms the instrument is set to monitor. The status of an alarm is displayed in different colors:

- Gray - The alarm is not enabled for reporting.
- Red - The alarm is occurring now.
- Yellow - The alarm is not occurring now, but has occurred within the last five seconds.
- Green - The alarm is not occurring and has not occurred within the last five seconds.

Alarm Status			Page 1 of 3
Alarm	Status	Additional Information	
SDI Input Missing	OK		
SDI Input Signal Lock	OK		
Reference Missing	OK		
Ref Lock	OK		
Ref Fmt Mismatch	OK		
RGB Gamut Error	Error	Rr—Bb	
Composite Gamut Error	Error	Cc	
Luma Gamut Error	Error	-1	
Video Fmt Change	OK		
Video Fmt Mismatch	OK		
Vid/Ref Mismatch	OK		
Video Not HD	Error	Detected 525i 59.94	
Line Length Error	OK		
Field Length Error	OK		
EAV Place Error	OK		
SAV Place Error	OK		
Y Anc Parity Error	OK		
C Anc Parity Error	OK		
AP CRC Error	OK		
FF CRC Error	OK		
EDH Error	OK		
Jitter1 Level	OK		
Jitter2 Level	OK		

ARIB Display: Decodes several types of ARIB data. You select the type of ARIB format to decode from the ARIB menu.

ARIB TR-B.22 Display						
DID:	5f (25f)	Type:	2	SDID:	e0 (1e0)	DC: ---
Field:	---	Line:	---	Stream:	---	---
Status:	Missing	Checksum:	---	Should be:	---	---
Format:	ARIB TR-B.22 XMIT Material Info					
000 016 032 048 064 080 096 112 128 144 160 176 192 208 224 240						

Auxiliary Data Status: Displays detailed information about the auxiliary data embedded in the video signal.

- **Closed Caption Type:** Displays the format and transport service of the detected closed caption data. "None Detected" is displayed when there is no closed caption data present.
- **V-Chip Rating:** Displays V-Chip rating. "None" is displayed when there is no V-Chip rating data present.
- **CC Services:** When closed caption data is detected, the closed caption service(s) being used are listed.
- **Ancillary Data Present:** "Present" is displayed when ancillary data is detected. "None" is displayed when there is no ancillary data present.
- **Transmission Signal Identifier:** Indicates whether the TSID is present in the SDI stream. If missing, "Absent" will display; otherwise, the TSID is displayed as a hexadecimal number.

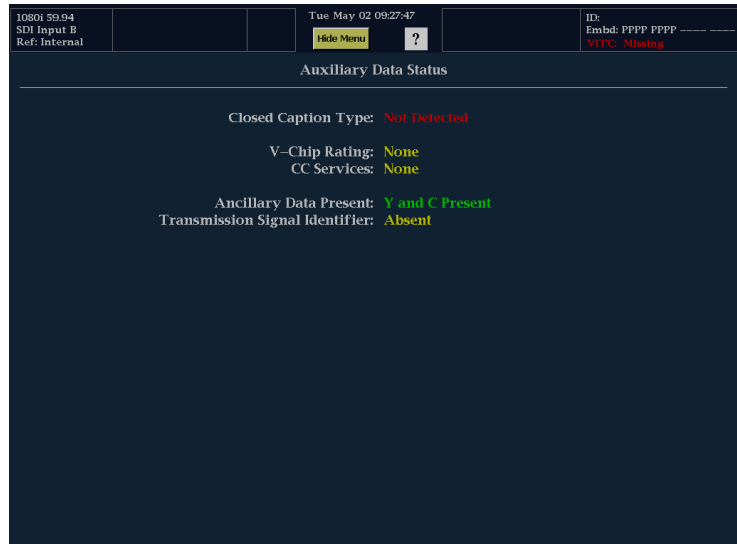

Dolby Status - Option DDE display shown with Dolby E source.



Dolby Status - Option DDE display shown with Dolby D source.

The screenshot shows the 'Dolby Audio Status' window with the following parameters:

Dolby Format:	Dolby D 32-bit	Copyright Bit:	Yes
Channel Mode:	2/0	Original Bitstream:	Yes
Dolby Source:	Embedded 1-2	Extended ESI:	
Dolby Data Rate:	384 kbps	Preferred Stereo Dmix:	N/A
Dolby Sample Rate:	48 kHz	L1/R1 Center Mix Lvl:	N/A
Bitstream Mode:	Complete Main	L1/R1 Surrnd Mix Lvl:	N/A
Dynamic Range Parameters			
Dialogue Level:	-27 dB	Lo/Ro Center Mix Lvl:	N/A
Line Mode Cmpr:	None	Lo/Ro Surrnd Mix Lvl:	N/A
RF Mode Cmpr:	-0.28 dB	Surround EX Mode:	N/A
RF Overmod Prot:	Disabled	Headphone Mode:	N/A
Center Mix Lvl:	N/A	A/D Converter Type:	N/A
Surrnd Mix Lvl:	N/A		
Dolby Surrnd Mode:	N/I		
Mixing Level:	N/I		
Room Type:	N/I		
SMPTE Timecode:	00:00:00:00		

Dolby Status - Option DD display shown with Dolby D source.

The screenshot shows the 'Dolby Audio Status' window with the following parameters:

Dolby Format:	Dolby D 32-bit	Copyright Bit:	Yes
Channel Mode:	2/0	Original Bitstream:	Yes
Dolby Source:	Embedded 1-2		
Dolby Data Rate:	384 kbps		
Dolby Sample Rate:	48 kHz		
Bitstream Mode:	Complete Main		
Dialogue Level:	-27 dB		
Center Mix Lvl:	N/A		
Surrnd Mix Lvl:	N/A		
Dolby Surrnd Mode:	N/I		
Mixing Level:	N/I		
Room Type:	N/I		
SMPTE Timecode:	00:00:00:00		

Video Session: Shows immediate status in the upper portion of the display and shows statistical overview of the entire session on the lower portion of the display. Statistics are controlled by the Run/Stop and Reset soft keys.

The screenshot shows the 'Video Session' screen. At the top, it displays '1080i 59.94 SDI Input B Ref: Internal' on the left, 'Tue May 02 09:31:38' in the center, and 'ID: Embd: PPPP PPPP VITC: Missing' on the right. Below this is a 'Video Session' header. The main area is divided into two columns of information. The left column lists: Input: SDI B, Signal: Locked, Format: Auto 1080i 59.94, 352M Payload: None, SAV Place Err: OK, Field Length Err: OK, Line Length Err: OK, Line Number Err: OK. The right column lists: Data Collect: Running, Run Time: 0 d, 00:05:08, Ancillary Data: Y and C Present, Y Stuck Bits: -----, C Stuck Bits: -----.

Statistics	Status	Err Secs	Err Fields	% Err Fields
RGB Gamut Error	OK	0	0	0.0000 %
Cmpst Gamut Error	C-	309	18443	100.0000 %
Luma Gamut Error	OK	0	0	0.0000 %
Y Chan CRC Error	OK	0	0	0.0000 %
C Chan CRC Error	OK	0	0	0.0000 %
Y Anc Checksum Error	OK	0	0	0.0000 %
C Anc Checksum Error	OK	0	0	0.0000 %

At the bottom, it says 'Changed since reset: Yes' and has 'Run/Stop' and 'Reset' buttons.

Error Log: Shows error over time. For errors to appear, Alarms must be enabled for logging in the Main>Config>Alarm Setup menu. The soft keys in the menu are used to navigate through the log. The error log is limited to 10,000 entries.

The screenshot shows the 'Error Status Log' screen. At the top, it displays '525i 59.94 SDI Input A Ref: Internal' on the left, 'Tue May 02 13:33:07' in the center, and 'ID: Embd: PPPP VITC: Missing' on the right. Below this is an 'Error Status Log' header. The main area is a table with columns: Error Status, Timecode, Date, and Time. The table contains several entries, each starting with a small 'i' icon. The entries are: Log Server State (Running) at 00:00:00:00 on 02-May-06 at 12:52:02; Audio Input Source (AES A) on 02-May-06 at 12:52:12; Detected Dolby Format (None) on 02-May-06 at 12:52:12; Video Input (SDI A) on 02-May-06 at 12:52:38; SDI Fmt (None (Detect (invalid format))) on 02-May-06 at 12:52:39; Cmpst Fmt (Auto None) on 02-May-06 at 12:52:39; Ref Input (Internal) on 02-May-06 at 12:52:39; Ref Fmt (Auto None) on 02-May-06 at 12:52:40; Audio Input Source (none) on 02-May-06 at 12:52:40; Audio Input Source (Embedded A) on 02-May-06 at 12:52:40; SDI Fmt (Auto None) on 02-May-06 at 12:52:40; SDI Fmt (Auto 525i 59.94) on 02-May-06 at 12:52:41.

At the bottom, there are navigation buttons: 'Prev', 'Next', 'First', 'Last', 'Run/Stop', and 'Reset'. The page number 'Page 1 of 1' is shown in the top right corner.

Audio Session: Shows immediate status in the upper portion of the display and shows statistical overview of the entire session on the lower portion of the display. Statistics are controlled by the Run/Stop and Reset soft keys.



Eye Display

Pressing the **MAIN** button calls up the Main pop-up menu. From the Main pop-up menu, you can select the **Eye** display under the **Eye/Phy** heading. The Eye pattern display presents a voltage-versus-time waveform of the input serial signal. This trace is composed of multiple samples of the SD or HD serial bit stream.

Depending on the options you have purchased, the waveform monitor supports checking, verification, and monitoring of the physical layer of SDI signals connected to its SDI inputs in the following ways:

- Option EYE. If present, the Eye option adds support for eye pattern monitoring of the physical layer of video signals. The Eye display includes readouts for P-P jitter, cable length and cable loss, and source level.
- Option PHY. The Phy option adds support for eye pattern monitoring of the physical layer of video signals and includes support for jitter waveform display. Additional measurements included with this option are amplitude, rise time, fall time, and rise-fall time difference.

The Eye display can be set to display eye measurements and limits.

1. **Jitter Thermometer:** The Jitter Thermometer is a visual indicator of the jitter amplitude. The Jitter Thermometer uses a colored bar to indicate the relationship of the jitter measurement to the Jitter Amplitude limit (which is user adjustable).
2. **Limits:** Touch any limit readout and use the knob to adjust the limit. Select Show Limits from the Settings menu to display these values. Option Eye has includes some of these limits; Option Phy includes additional limits.
3. **V Gain & H Mag:** Adjust the vertical gain and horizontal magnification with these touchable readouts.
4. **Eye parameter measurements:** Option Phy adds on-screen display of eye and jitter measurements. Option Eye has includes some of these measurements; Option Phy includes additional measurements.
5. **Line Select:** When in Line Select mode, use the knob to select which line is being viewed.

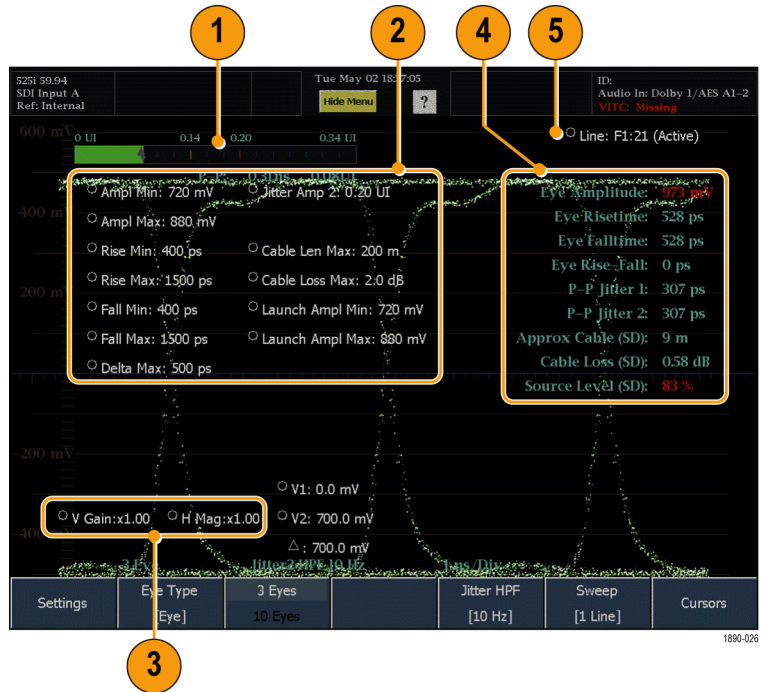

Jitter Display

Pressing the **MAIN** button calls up the Main pop-up menu. From the Main pop-up menu, you can select the **Jitter** display under the **Eye/Phy** heading. The Jitter display presents a Unit Interval-versus-time waveform of the input serial signal. This trace is composed of multiple samples of the SD or HD serial bit stream.

To view the Jitter display, you must have Option Phy installed.

The Jitter display can be set to display measurements and limits.

1. **Jitter gauge:** Augment the jitter readouts with an easy-to-read visual indicator.
2. **Limits:** Touch any limit readout and use the knob to adjust the limit. Select **Show Limits** from the Settings menu to display these values.
3. **V Gain & H Mag:** Adjust the vertical gain and horizontal magnification with these labels.
4. **Eye and Jitter measurements:** Select **Show Measure** from the Settings menu to display these values.
5. **Line:** When in Line Select mode, use the knob to select which line is being viewed.

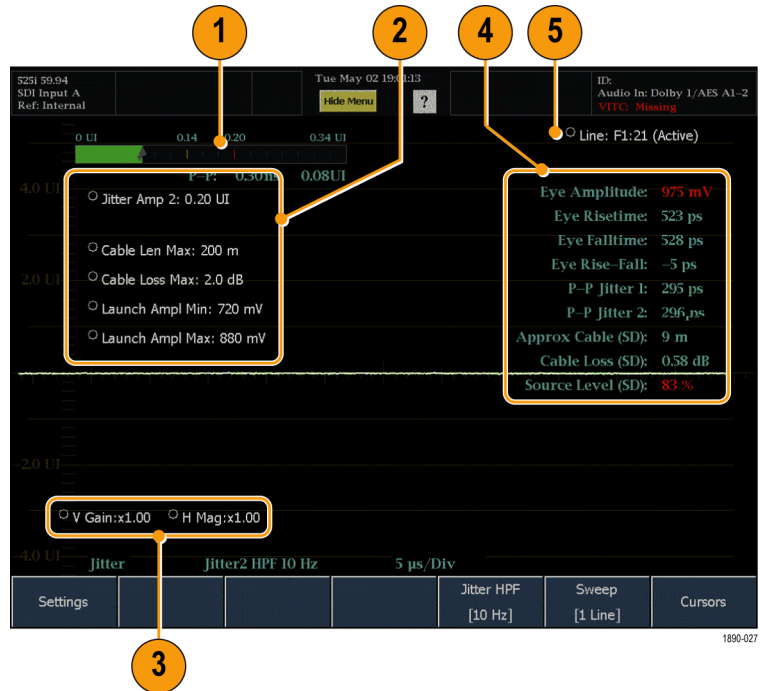

SDI Status Display

The SDI Status display shows the current status of the SDI signal. This display shows both the Jitter1 and Jitter2 thermometers. Additionally, a Cable Loss thermometer indicates the signal loss due to cable length. Use the Settings menu in the Eye display to configure the instrument for the cable type and length of your installation. With Option Phy installed, the SDI Status Display also shows the eye amplitude, eye rise time, eye fall time, and eye rise-fall delta measurement values. To view the SDI Status display, the instrument must have Option Eye or Phy installed.

There are two Jitter Thermometers in the SDI Status display because there are two independent clock recovery circuits in the instrument and each circuit can be set to a different bandwidth. Note that the Eye and the Jitter displays share these two circuits. The upper two tiles use clock recovery circuit one, and the lower two tiles use clock recovery circuit two. This means that any combination of Eye and Jitter displays in the top two tiles will have the same bandwidth, but any combination of eye and jitter in the left or right two tiles can have any two bandwidths from the list of possible choices.

Elements of the SDI Status Display:

- Jitter1 and Jitter2 thermometers and readouts:** The Jitter Thermometer uses a colored bar to indicate the relationship of the jitter measurement to the Jitter Amplitude limit (which is user adjustable from the Eye or Jitter display).
- Cable Loss Thermometer and readouts:** The Cable Loss Thermometer works just like the Jitter Thermometer, using color to indicate the relationship of the measurement to the Cable Loss limit (which is user adjustable from the Eye or Jitter display).
- Eye Measurements:** With Option Phy installed, a set of eye measurements are displayed below the Cable Loss measurements.



Monitoring the SDI Physical Layer

With Options Eye and Phy, the waveform monitor supports the checking, verification, and monitoring of the SDI physical layer in the following ways:

- **Option Eye.** If present, this option adds support for eye pattern monitoring of the physical layer of video signals. WFM6100 instruments display eye patterns for only SD signals. WFM7100 instruments display eye patterns for both HD and SD signals, when the options are installed.
- **Option PHY.** If present, this option includes the Option Eye features and adds automatic eye measurements and a jitter waveform to aid the monitoring of the SDI physical layer. WFM6100 instruments display jitter waveforms for only SD signals. WFM7100 instruments display jitter waveforms for both HD and SD signals, when the options are installed.

With Options Eye and PHY installed, you can use the following display modes to monitor the SDI physical layer:

- **Eye Display.** On this display, you can use the voltage and time measurement cursors and their readouts to monitor amplitude and timing measurements on the Eye waveform. A jitter thermometer and readout displays the jitter magnitude. You can set the high-pass filter to allow measurement of different jitter types (timing and alignment). The jitter thermometer graphically relates the jitter measurement to the alarm limits.
- **Jitter Display.** On this display, you can view additional time-domain information, such as that listed below, that is useful in separating sources of jitter, whether they are within a single circuit on a circuit board, or from various pieces of equipment in a system.
 - Jitter components that are synchronous or nearly synchronous to video line or frame. These appear as stationary or near-stationary artifacts in line or field sweeps.
 - The wave shape of the jitter as modified by the high-pass filter setting.
- **SDI Status Display.** This display shows both the Jitter1 and Jitter2 thermometers described above. Additionally, a Cable Loss thermometer indicates the signal loss due to cable length. Use the Eye Settings menu to configure the instrument for the cable type and allowed length. With Option Phy installed, the SDI Status Display also shows the eye amplitude, eye rise time, eye fall time, and eye rise-fall delta measurement values.

To Configure the Physical Layer Settings

Before you use Eye display to monitor the SDI physical layer, you should configure the eye and physical layer settings, as described on the following pages. The eye and physical layer settings are initially set to FACTORY defaults. (See page 36, *To Rename a Preset or Group.*)

Displaying the Eye Measurement Menu

The following procedures require that you have enabled the Eye measurement, and are displaying the Eye soft key menu items.

1. Press the **Main** front-panel button.

2. Touch the **Eye** soft key. The instrument displays the Eye soft key menu items.

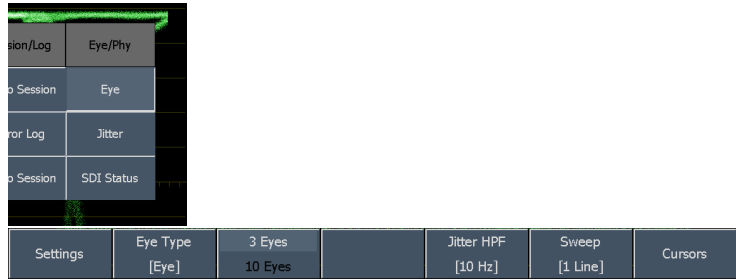

Setting the Cable Type

1. Touch the **Settings** soft key. (See page 86, *Displaying the Eye Measurement Menu.*)
2. Touch the **Cable Type** soft key.
3. Select the best match for the type of cable connecting the SDI signal you are measuring.
4. Touch the **Close Cable Type** and **Close Settings** soft keys.

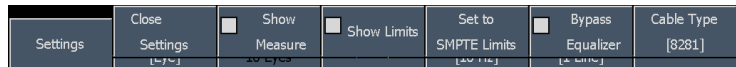

Usage Note

Most serial receivers specify cable accommodation for 8281 or 1694A. Even if you use a different cable, you can use the 8281 or 1694A setting and evaluate the loss as if it were that cable type. This allows you to compare the specification for the receiver regardless of the actual cable type in use.

If you need to measure launch amplitude or physical length, you must set the cable type to the actual cable used.

Setting the Eye Type

1. Touch the **Eye Type** soft key.
(See page 86, *Displaying the Eye Measurement Menu.*)



2. Select one of the following:

- **Eye.** The Eye display shows the SDI input signal directly.
- **Equalized Eye.** The Eye display shows the SDI input signal after it has passed through the internal cable equalizer and comparator.

3. Touch the **Close Eye Type** soft key.

Setting the Jitter High Pass Filter

1. Touch the **Jitter HPF** soft key and select a high-pass filter value. (See page 86, *Displaying the Eye Measurement Menu.*)

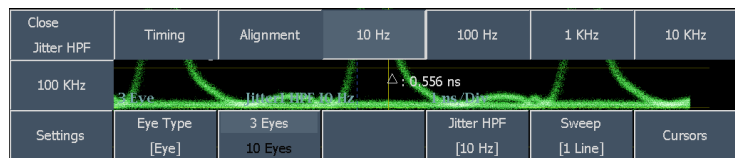

NOTE. **Timing** sets the filter value to 10 Hz. **Alignment** sets the filter value to 1 kHz for SD or 100 kHz for HD.

2. Touch the **Close Jitter HPF** soft key.

Setting the SMPTE 259/292 Alarm Thresholds

1. Touch the **Settings** soft key. (See page 86, *Displaying the Eye Measurement Menu.*)

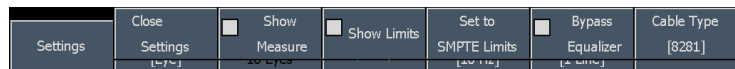

- To reset both the SMPTE 259 (SD) and SMPTE 292 (HD) monitoring alarm thresholds back to the factory-default values, touch the **Set to SMPTE259/292 Limits** soft key.

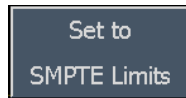

Setting the SMPTE limits also sets both clock recovery circuits to measure both timing and alignment jitter. This can be seen on the SDI Status display.

- To set individual threshold limits, touch the **Show Limits** soft key (in the Settings submenu) to enable displaying of the limit values. Which threshold limits are displayed depends on the installed options.



- Touch the limit value to set and use the general-purpose knob to change the value.

NOTE. You can use the **SELECT** front-panel button to sequentially step through and select the threshold limit values.

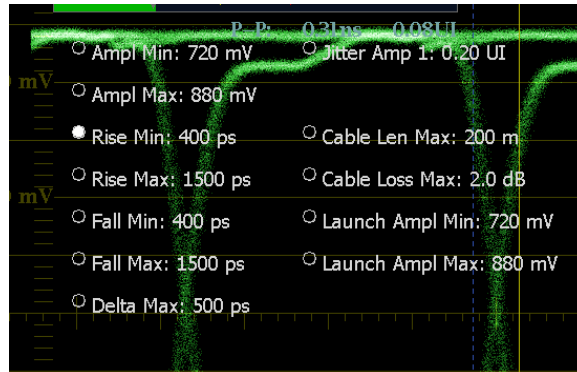

- Touch the **Close Settings** soft key.

Setting the Equalizer Bypass

- Touch the **Settings** soft key. (See page 86, *Displaying the Eye Measurement Menu.*)



2. Touch the **Bypass Equalizer** soft key to toggle the setting on or off:



- **On.** Bypass the equalizer when the waveform monitor is connected to a signal with a short length of cable to minimize the jitter contributed by the internal equalizer. This setting is generally used only for very low-jitter signals.
- **Off.** Enables the equalizer, which enables operation with typical cable lengths and reduces jitter due to cable effects. Use this setting for most signals.



CAUTION. *If the equalizer is left in bypass mode, the waveform monitor will not work with cables more than a few meters long. This applies to all SDI displays.*

3. Touch the **Close Settings** soft key.

To Configure Physical Layer Alarms

1. Press the **Main** front-panel button.
2. Touch the **Config** soft key.
3. Touch the **Alarm Setup** soft key to open the alarm setup controls.

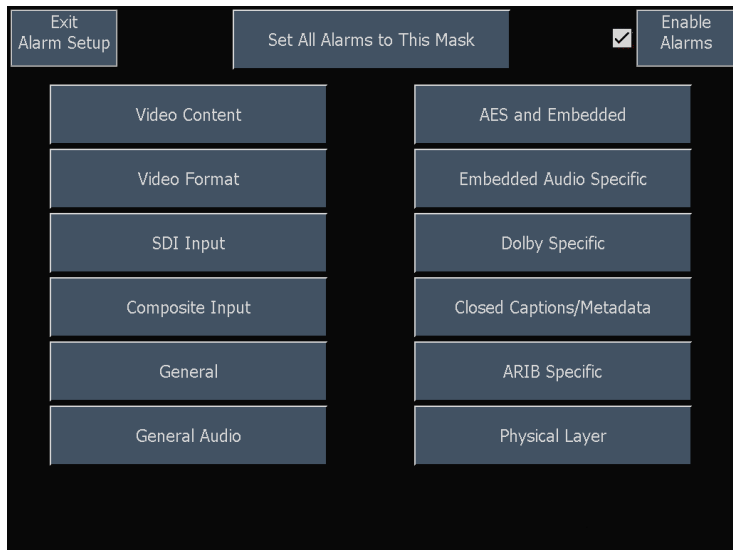

4. Touch the **Enable Alarms** soft key to turn on or off all limit alarms. When Enable Alarms is turned off, no alarms are reported: this function is useful as a global mute in the event of multiple alarms that occur at the same time.

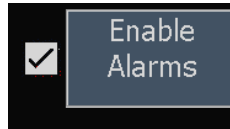

5. To set the same alarm notification types for any alarm error condition, touch the **Set All Alarms to This Mask** soft key. The instrument displays the alarm notification types. Select one or more alarm notification types. For a description of the alarm notification types, access the Online help for the Alarm Setup soft key (display the **Config** menu, touch the Online Help soft key, and then touch the **Alarm Setup** soft key).

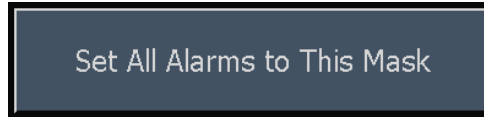

6. To set individual limit alarms for specific error conditions, touch the soft key for the appropriate measurement category. The instrument displays the available error conditions that can trigger an alarm, and the alarm notification types.

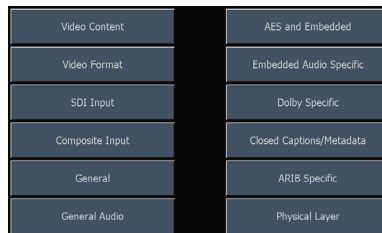

7. Select the alarm notification types for one or more error conditions.
8. Touch the **Save and Close** soft key to save the alarm settings and return to the previous screen. Touch the **Cancel and Close** to cancel changes to the alarm settings and return to the previous screen.

	Save and Close	Cancel and Close				
SDI INPUT			Txt/Icon	Log	Beep	SNMP
SDI Input Missing	<input type="checkbox"/>	<input type="checkbox"/>	<input type="checkbox"/>	<input type="checkbox"/>	<input type="checkbox"/>	<input type="checkbox"/>
SDI Input Unlocked	<input type="checkbox"/>	<input type="checkbox"/>	<input type="checkbox"/>	<input type="checkbox"/>	<input type="checkbox"/>	<input type="checkbox"/>
AP CRC Alarm	<input type="checkbox"/>	<input type="checkbox"/>	<input type="checkbox"/>	<input type="checkbox"/>	<input type="checkbox"/>	<input type="checkbox"/>
FF CRC Alarm	<input type="checkbox"/>	<input type="checkbox"/>	<input type="checkbox"/>	<input type="checkbox"/>	<input type="checkbox"/>	<input type="checkbox"/>
EDH Alarm	<input type="checkbox"/>	<input type="checkbox"/>	<input type="checkbox"/>	<input type="checkbox"/>	<input type="checkbox"/>	<input type="checkbox"/>
Y Chan CRC Error	<input type="checkbox"/>	<input type="checkbox"/>	<input type="checkbox"/>	<input type="checkbox"/>	<input type="checkbox"/>	<input type="checkbox"/>
C Chan CRC Error	<input type="checkbox"/>	<input type="checkbox"/>	<input type="checkbox"/>	<input type="checkbox"/>	<input type="checkbox"/>	<input type="checkbox"/>
Y Anc Checksum Error	<input type="checkbox"/>	<input type="checkbox"/>	<input type="checkbox"/>	<input type="checkbox"/>	<input type="checkbox"/>	<input type="checkbox"/>
C Anc Checksum Error	<input type="checkbox"/>	<input type="checkbox"/>	<input type="checkbox"/>	<input type="checkbox"/>	<input type="checkbox"/>	<input type="checkbox"/>
Y Anc Parity Error	<input type="checkbox"/>	<input type="checkbox"/>	<input type="checkbox"/>	<input type="checkbox"/>	<input type="checkbox"/>	<input type="checkbox"/>
C Anc Parity Error	<input type="checkbox"/>	<input type="checkbox"/>	<input type="checkbox"/>	<input type="checkbox"/>	<input type="checkbox"/>	<input type="checkbox"/>
SMPTTE 352M Missing	<input type="checkbox"/>	<input type="checkbox"/>	<input type="checkbox"/>	<input type="checkbox"/>	<input type="checkbox"/>	<input type="checkbox"/>

9. Touch the **Exit Alarm Setup** soft key to close the alarm setup screen and return to the instrument display.

To Take Eye Measurements

After you have configured the instrument for Eye measurements, you can use the cursors to take manual waveform measurements, or you can use the automatic eye measurements function (Option Phy only).

To Set Up for Eye Measurements

1. Configure the instrument to monitor the SDI physical layer. (See page 86, *To Configure the Physical Layer Settings*.)
2. Connect a serial video-signal to the instrument using a 75 Ω cable of two meters or less in length. Use high-quality, low-loss coaxial cable, such as Belden 1694A.
3. Press the **MAIN** front-panel button.
4. Touch the **Eye** soft key to display the Eye soft key menu.

The procedures on the following pages describe how to take manual measurements of the Eye waveform. If Option Phy is installed, the instrument can also take automatic eye measurements.

NOTE. *If you use the measurement cursors to measure the eye waveform, you may measure a different result than that shown in the automatic eye measurements readout. This is because the automatic amplitude measurement uses histograms in order to be minimally affected by overshoot, ringing and noise on the signal. Similarly, the automatic rise time and fall time measurements use histograms to find the centers of the distributions of 20% and 80% crossings. The difference between manual and automatic measurements is usually insignificant for clean, symmetrical signals.*

To Manually Measure Eye Amplitude

1. Perform the initial setup for Eye measurements. (See page 92, *To Set Up for Eye Measurements*.)
2. Touch the **Cursors** soft key. The instrument displays the cursors submenu.
3. Select the **Show Volt** soft key to enable display of the voltage cursors. Voltage cursor V1 is selected by default.

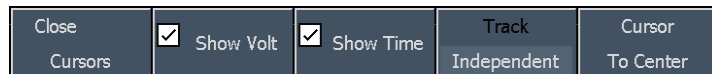

- Use the general-purpose knob to position cursor V1 at the top part of the waveform, ignoring any overshoot or undershoot on the rising or falling edges.

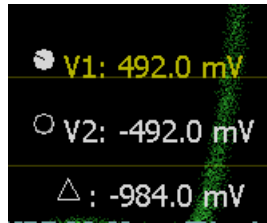

- Press the **SELECT** front-panel button to select voltage cursor V2.
- Use the general-purpose knob to position the second voltage cursor at the bottom of the waveform, ignoring any overshoot or undershoot on the rising or falling edges.

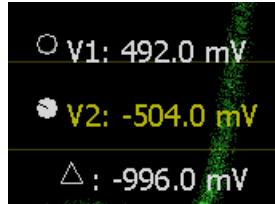

- The cursor Delta readout displays the amplitude of the eye waveform.

NOTE. Signal-source amplitudes outside of $\pm 10\%$ of 800 mV p-p can degrade receiver performance.

To Manually Measure Aberrations

- Perform the initial setup for Eye measurements. (See page 92, *To Set Up for Eye Measurements*.)
- Touch the **Cursors** soft key. The instrument displays the cursors submenu.
- Select the **Show Volt** soft key to enable display of the voltage cursors. Voltage cursor V1 is selected by default.



4. Use the general-purpose knob to position voltage cursor V1 at the peak of the overshoot at the top horizontal part of the waveform.
5. Select cursor V2 and use the general-purpose knob to position the voltage cursor V2 at the bottom of the top line of the waveform. Include any ringing (the oscillation following overshoot) in the measurement. Essentially, you are measuring the thickness of the top line of the waveform.

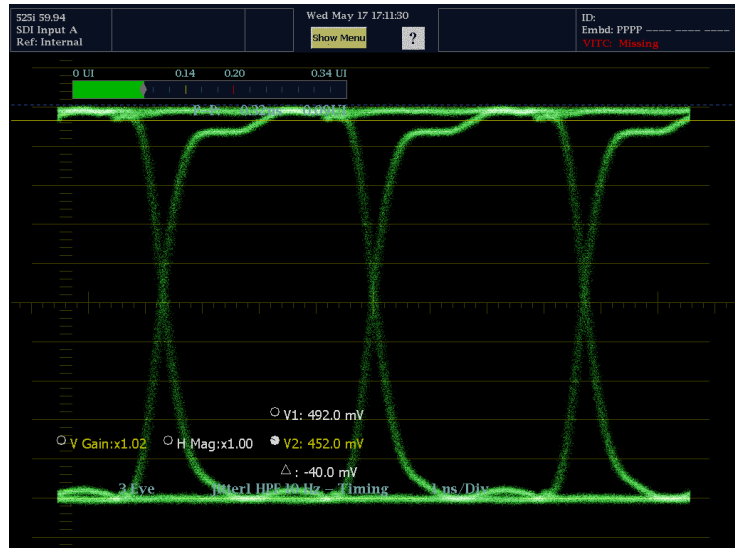

6. The cursor Delta readout displays the amplitude of the aberration.
7. Perform the same voltage-cursor measurement on the bottom line thickness, including any undershoot and ringing.

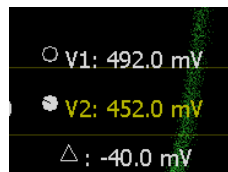

NOTE. Aberrations at the top or bottom line of the waveform should not exceed 10% of the signal amplitude. Automatic equalizer circuits in receivers may be sensitive to larger aberrations.

To Manually Measure Rise Time Using Variable Gain

1. Perform the initial setup for Eye measurements. (See page 92, *To Set Up for Eye Measurements.*)
2. Press the **MAG/GAIN** front-panel button.



3. Touch the **Vert Var Gain Enable** soft key to enable variable gain adjustment, and use the general-purpose knob to set the waveform height to 10 major graticule divisions.
4. Use the **VERT** knob to position the top and bottom of the waveform on graticule lines.

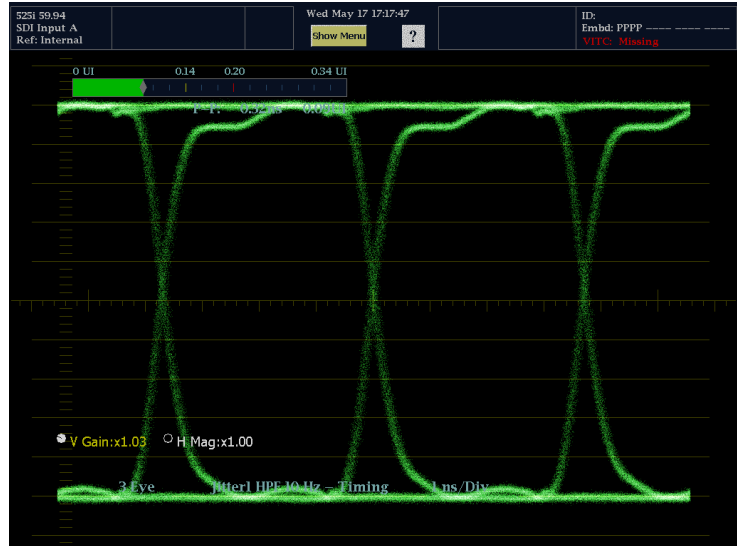

5. Press the **MAIN** front-panel button.
6. Touch the **Eye** soft key.
7. Touch the **Cursors** soft key. The instrument displays the cursors submenu.
8. Select the **Show Timing** soft key to enable display of the voltage cursors. Timing cursor T1 is selected by default.



9. Use the general-purpose knob to position timing cursor T1 at the crossing of the rising edge of the Eye waveform and the graticule line two divisions above the bottom of the waveform.
10. Select timing cursor T2.
11. Use the general-purpose knob to position the timing cursor T2 at the crossing of the rising edge of the Eye waveform and the graticule line two divisions below the top of the waveform.

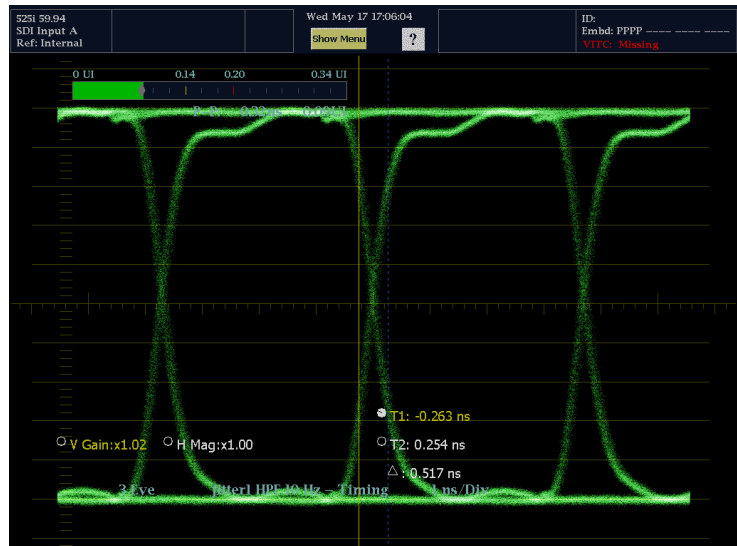

- The cursor Delta time readout displays the 20 - 80% rise time measurement.

To Take Automatic Eye Measurements (Option Phy Only)

The following procedure describes how to take automatic measurements of the Eye waveform when Option Phy is installed.

- Perform the initial setup for Eye measurements. (See page 92, *To Set Up for Eye Measurements.*)
- Display the Eye measurement in full-screen mode.

NOTE. Eye measurements are shown on the Eye and Jitter displays only in full-screen mode. However, the measurements are displayed on the SDI Status display.

- Touch the **Settings** soft key to display the Settings submenu.



- Touch the **Show Measure** soft key. The measurements are displayed on the left side of the screen.

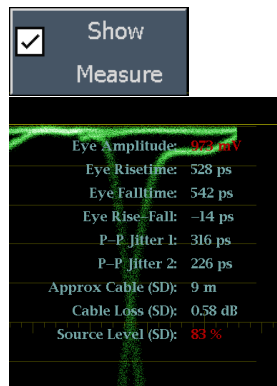

NOTE. If you use the measurement cursors to measure the eye waveform, you may measure a different result than that shown in the automatic eye measurements readout. This is because the automatic amplitude measurement uses histograms in order to be minimally affected by overshoot, ringing and noise on the signal.

Similarly, the automatic rise time and fall time measurements use histograms to find the centers of the distributions of 20% and 80% crossings. The difference between manual and automatic measurements is usually insignificant for clean, symmetrical signals.

Timing a Studio

Timing a studio involves adjusting the references going to different sources so that their output feeds have the same timing when they arrive a common point, such as a production switcher. For digital systems, the timing typically only needs to be close, because most switchers have some tolerance to timing errors. For analog composite systems, the timing may need to be matched within a small part of a subcarrier cycle to prevent hue shifts when switching between sources.

The waveform monitor supports multiple methods and techniques of timing a studio. All of these methods require an external reference to the waveform monitors.

Using the Timing-Display Method

The Tektronix proprietary Timing Display (patent pending) provides an easy to use measure of the timing of an input relative to the external reference:

- The rectangular display automatically scales to match the input signal. For progressive signals the display represents one field, for interlace signals the display represents one frame, and for composite inputs the display represents one color frame.
- The cross-hair in the center represents zero offset, and the circle represents the timing of the input signal. Lines of advance or delay are shown as vertical displacement, while timing errors of less than one line are shown as horizontal displacement. If the input is at the same time as the reference, then the circle will be centered on the cross-hair.
- The timing offset is also shown numerically as lines and microseconds of advance or delay in the boxes at the right side of the display.
- For input and reference signals with closely related frame rates, there is only one timing relationship, so a single circle is shown on the display to indicate the timing offset of the input signal.
- For input and reference combinations with more complex relationships, multiple circles are displayed to indicate all the possible interpretations of the timing offset, with the one that is closest to zero shown with emphasis. The numerical readouts will correspond to the timing indicator circle with the emphasis.
- The Relative to: box indicates the chosen zero point for the timing display. The default is Rear Panel. In this mode, the offset is zero when the input and reference are at the same timing at the rear panel of the waveform monitor. The other choice is Saved Offset. In this mode, you can save the timing from one signal and then display the timing relative to that saved offset.

To use the Timing display to time a signal to a reference:

1. Select a tile in which to time the active input.
2. Apply the input signal to be timed to the appropriate input, terminate it properly if necessary, and then select it from the IN/OUT menu.
3. Apply the house reference signal to the external reference input.
4. Press **IN/OUT** and then select **Ext Ref** to set the reference to external mode. (Connected to the house reference.)

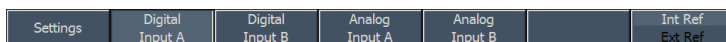

5. Press **MAIN** to display the Main pop-up menu and select the Timing display for the tile selected in step 1.
6. If only one circle is displayed, adjust the timing offset of the black generator to match the timing to the external reference. Adjust for a perfect coincidence of the circle around the reference target (circle turns green at coincidence) and null values of the vertical and horizontal timing readouts.

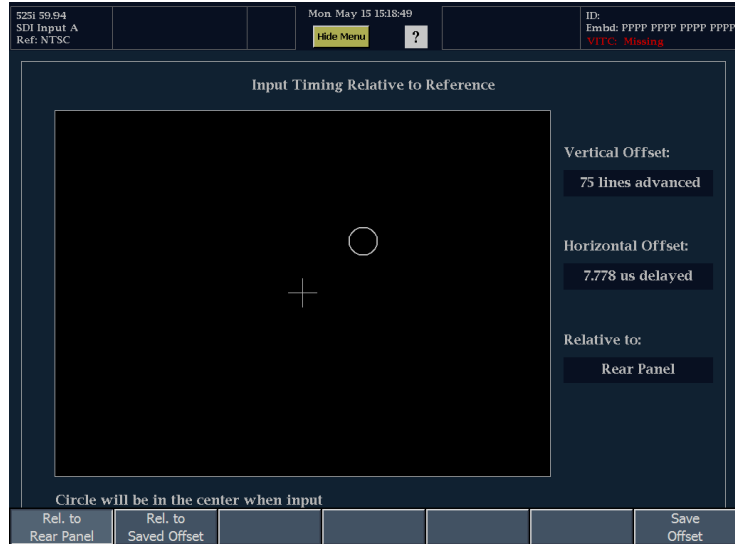

7. If multiple circles are displayed, the timing is complex, and you must choose which circle you want. The measurement that is closest to zero offset is displayed with emphasis and appears in the readouts.

NOTE. For additional information on complex timing displays, see the previous discussion for information on this display and its elements. (See page 73, *Timing Displays for Simple Versus Complex Timing.*)

8. Repeat step 6 or 7 for any other signals.

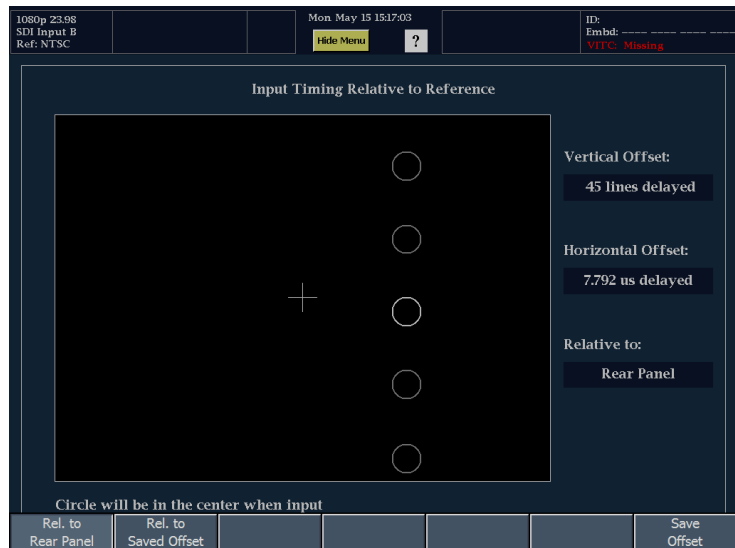

NOTE. As you adjust timing, the circle representing the input timing may jump occasionally. This is because the color frame detection circuit can be temporarily disrupted as the signal shifts. The jump is often a multiple of the field time. The circle will settle back to the correct location in a second or so.

Usage Notes

- The resolution of the timing display for Composite and SD signals is one 27 MHz clock cycle or 37 ns. For HD signals, it is one clock at 74.25 MHz, which equates to about 13.5 ns. To get the greater accuracy needed for a composite signal, first use the timing display to get close, then use a vector display for the final burst phase alignment. Since the waveform monitor can display both the timing display and a vector display simultaneously (each in its own tile), this process can still be easy and quick.

- For composite signals the definition of time aligned is obvious but for an SDI input relative to a analog reference the situation is more complex. For the timing display, the definition of zero offset on an SDI input uses the methodology described in SMPTE RP168. This method specifies the SDI signal will be converted to analog. The converted analog signal is then compared to the analog reference. For the conversion a D/A converter with delay of about three microseconds is used.
- In the relative to rear panel mode, this three microsecond conversion delay is accounted for in the displayed offset. In the Relative to Saved Offset mode, it has no effect.

Timing Multiple Inputs to a Router

You can also use the Relative to: function to set the offset between a master and a reference signals as the zero-point reference for time-down applications. The **Relative to:** box indicates the chosen zero point for the timing display:

- **Rear Panel.** In this mode (default), the offset is zero when the measured signal input and reference are at the same timing at the reference at the instrument rear panel. This setting was used in the Timing Display Method procedure.
- **Saved Offset.** In this mode, you can save the timing from a master signal relative to the reference as the zero point offset. Then route other inputs and measure relative to this saved offset.

To time the inputs to a router:

1. Apply the reference signal to the Ref Loop.

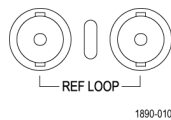

2. Select the master input to the router and connect it to the Composite or SDI input as required.

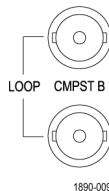
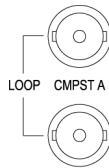
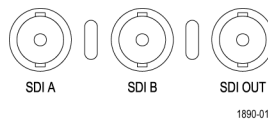

- Press the **MAIN** button to display the Main pop-up menu. Select the **Timing** display from the pop-up menu.

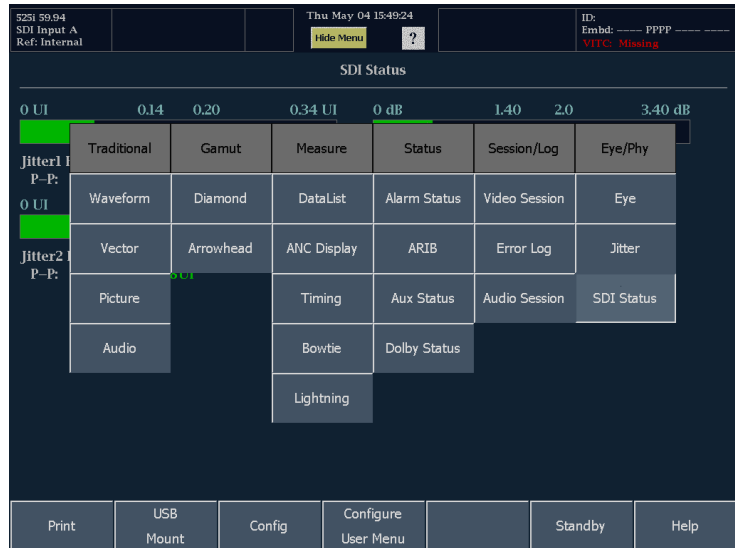

- Touch **Save Offset** from the Timing menu.
- Touch the **Rel. to Saved Offset** soft key¹. The timing of the first input (the master signal) is at the center of the screen.

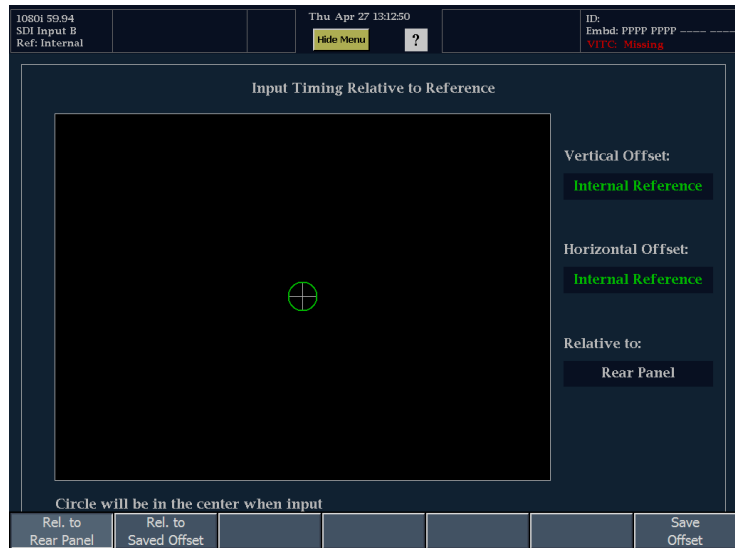

6. Remove the master input signal from the waveform monitor and in its place, apply another input to the router.
7. Adjust the sync source or studio timing of that signal so that it matches the saved timing. When the timing matches, the circle and cross in the display will both be at the center of the Timing display.

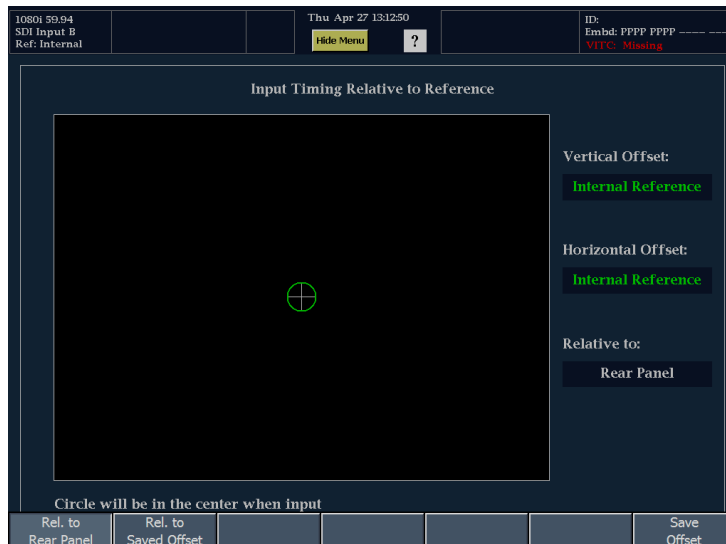

- 1 You cannot save the timing offset if either the input or reference is missing or unlocked. You also cannot save a reference when in internal mode. Saving an offset in these conditions would lead to misleading results so it is not allowed by the instrument.

Usage Notes

- This timing relationship between input and reference is also compatible with waveform mode. That is, if you have zero timing on the Timing display and change from internal to external reference, the displayed waveform will not shift position.
- When timing analog composite signals, first use the Timing display to get within one clock cycle, then adjust system phase with the Vector display. (See page 63, *Vector Display*.)
- If you have an input and reference combination that requires multiple timing indicator circles, then it can be misleading to compare timing offsets between multiple inputs. Because the timing display chooses the smallest of the possible timing offsets, if a large timing difference exists between two inputs, then they may not be matched. This problem will also occur using traditional timing methods unless one uses something similar to the SMPTE318 10 field flag to identify a specific submultiple of the reference.

Checking Chroma/Luma Delay (Lightning Display)

The Lightning display can be used for interchannel timing measurement. If the color-difference signal is not coincident with luma, the transitions between the color dots will deviate from the center mark of a delay scale. The amount deviated represents the relative signal delay between luma and color-difference signal.

1. Connect a signal containing color bar information.
2. Press the IN/OUT button to display the IN/OUT menu.

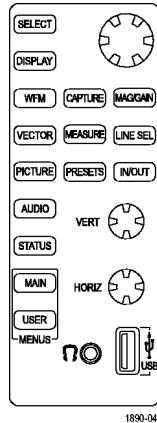

3. Select the input corresponding to the connected signal.
4. Select a tile.

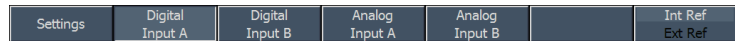

Statistics	Status	Err Secs	Err Fields	% Err Fields
RGB Gamut Error	OK	68	3913	4.8095 %
Comp Gamut Error	OK	1297	77286	94.9938 %
Luma Gamut Error	OK	66	3532	4.3413 %
F1 AP CRC Error	OK	0	0	0.0000 %
F2 AP CRC Error	OK	0	0	0.0000 %
AP CRC Error	OK	0	0	0.0000 %
AP CRC Error	OK	0	0	0.0000 %

5. Press the MAIN button to display the Main pop-up menu.
6. From the Main pop-up menu, touch **Lightning** to display the signal in a Lightning display.

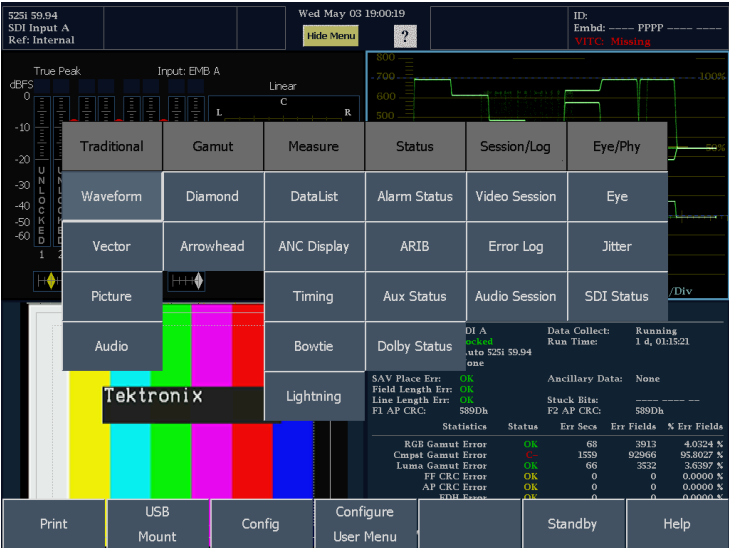

7. Press the **DISPLAY** button.
8. Touch the view soft key that corresponds to the tile containing the Lightning display. This will display the Lightning display in full-screen mode.

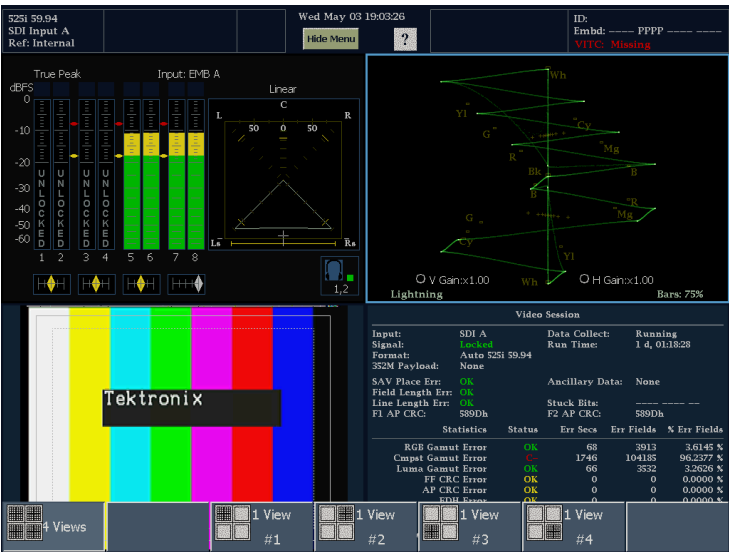

9. Set Bar Targets to match your input signal.



10. Determine where transitions intersect the delay scales and derive the timing error in nanoseconds, as deflected from center mark. See the following table.

- The center mark of the nine marks spanning at each green-magenta transition is the zero error point.
- Alignment to a mark towards black means the color-difference signal lags with respect to luma.
- Alignment to a mark towards white means the color-difference signal leads the luma signal.
- The upper half of the display measures the Pb to Y timing; the bottom half measures the Pr to Y timing.

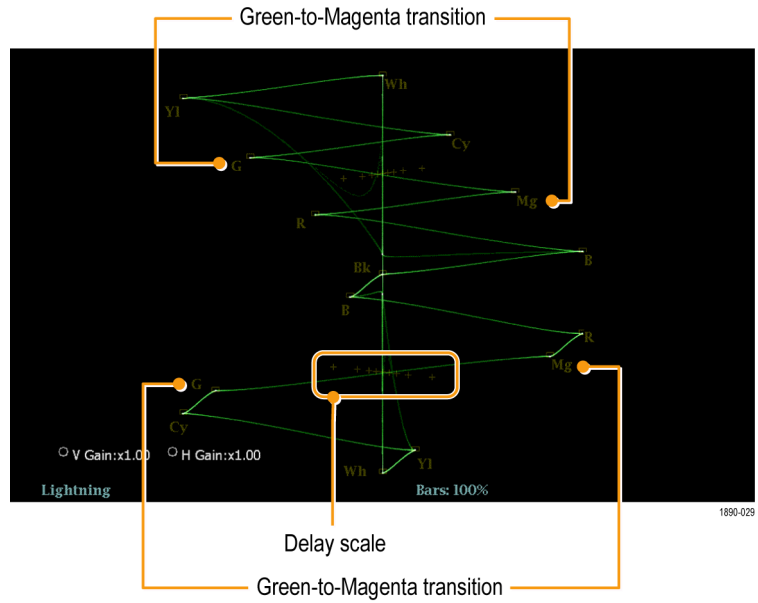

11. You can use the V Gain and H Gain settings (touch the readouts and use the knob to adjust) to expand the scale of the Lightning display to make it easier to read the delay scale.

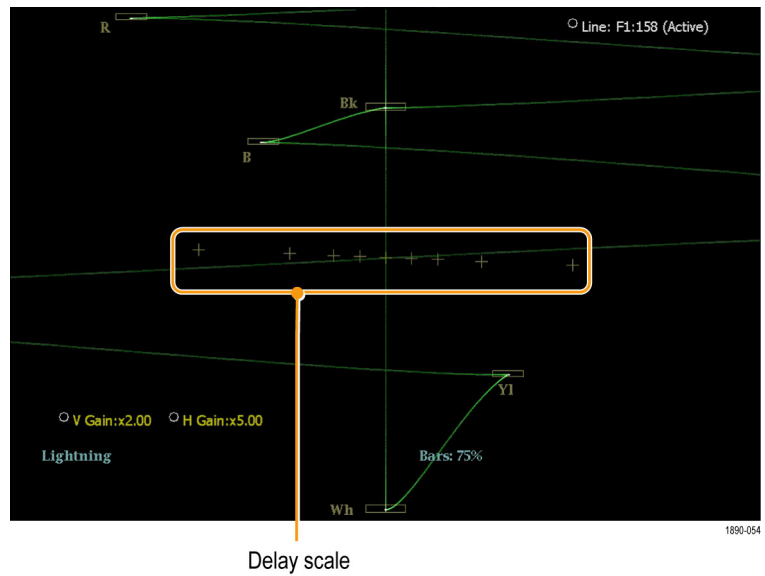

Deflection	SD	HD
0 marks	0 ns	0 ns
±1 mark	20 ns	2 ns
±2 marks	40 ns	5 ns
±3 marks ¹	74 ns	13.5 ns
±4 marks ²	148 ns	27 ns

¹ Luma sample
² Chroma sample

Checking Gamut

Signals that are legal and valid in one signal representation may not be legal in another representation. Specifically, signals that are legal in the Digital YCbCr representation may not be legal if transcoded to RGB or encoded to NTSC / PAL. Any signal that fails this test is considered out of gamut for these color spaces.

The waveform monitor supports multiple displays and alarms to allow detecting out of gamut signals. The flexible tile display allows you to simultaneously view several of the gamut measurements to learn which is most appropriate for a given application. The displays are:

- Diamond for checking that SDI signals conform to legal RGB gamut space (which appears as a Split Diamond on the WFM6100/WFM7000/WFM7100 monitors, and separates the upper and lower diamonds to show excursions below black)
- Arrowhead for checking if an SDI signal is legal for composite color space
- Composite Waveform modes for checking both SDI and composite signals for legality in composite color space

Diamond and Arrowhead have adjustable thresholds. If the signal goes outside the area defined by the thresholds, the signal is out of gamut. If these limits are exceeded then the waveform monitor can generate alarms if configured to do so. For composite waveforms, the legal limit is simply the maximum level allowed for the combination of luma and chroma. This limit depends on application. For example, a recording on a tape may be able to handle a larger signal than if driving into a transmitter.

The waveform monitor also provides “brightups” for checking gamut. Brightups, or contrast patterns, appear on areas of the Picture display that are out of gamut as defined by the different threshold settings. Brightups can be displayed for RGB gamut errors, Composite gamut errors, and Luma gamut errors. To set thresholds for brightups, adjust the thresholds in the Diamond and Arrowhead displays.

Setting up for Gamut Checks

1. Connect a signal containing color bar information.
For set up purposes, the use of a color bar signal is suggested, but these displays are useful on all signals.
2. Press the IN/OUT button to display the IN/OUT menu.

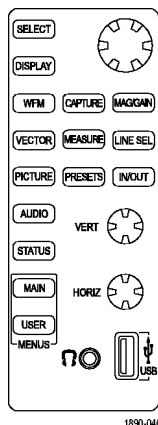

1890-040

3. Select the input corresponding to the signal connected.

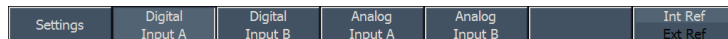

4. Select a tile.

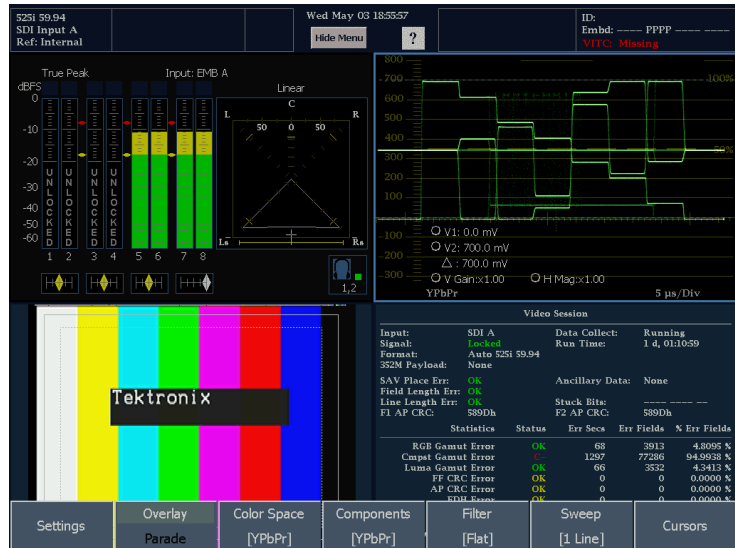

5. Press the MAIN button to display the Main menu.

6. From the Main menu, select one of the two gamut displays:

- Diamond - use to detect, isolate, and correct RGB component gamut errors.
- Arrowhead - use to detect and correct composite gamut errors, without employing a composite encoder.

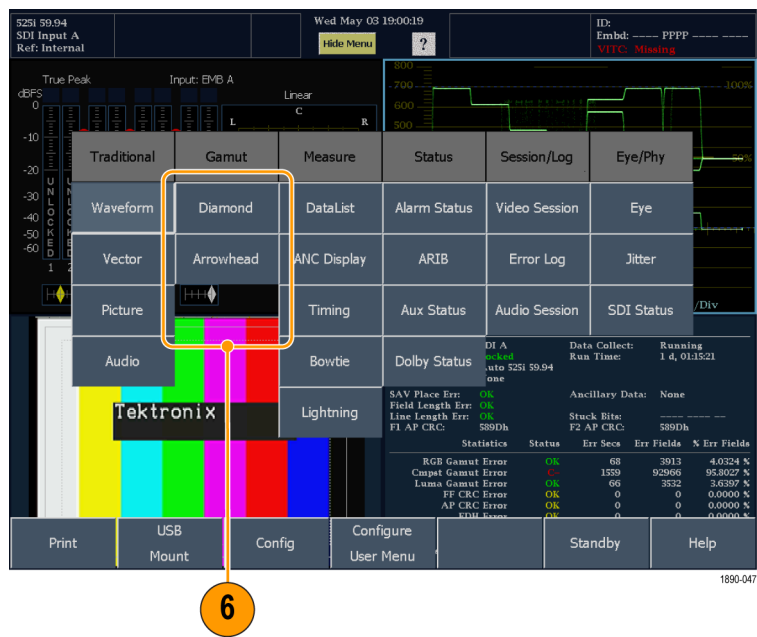

Example of an Arrowhead display.

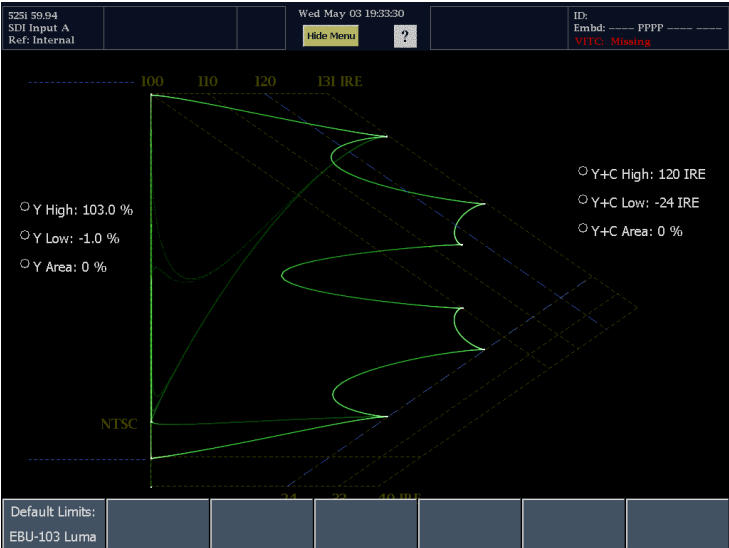

Checking RGB Gamut

The Diamond display intuitively shows how the R, G, and B signal video signals relate, making it a good tool for detecting gamut errors. The waveform monitor converts the Y , P_b , and P_r components recovered from the serial signal to R, G, and B to form the Diamond display. To predictably display all three components on a monitor, they must lie between peak white, 700 mV, and black, 0 V. For a signal to be in gamut, all signal vectors must lie within the G-B and G-R diamonds. Conversely, if a signal vector extends outside the diamond, it is out of gamut. The direction of an excursion out of gamut indicates which signal is excessive. Errors in green amplitude affect both diamonds equally, blue amplitude errors affect only the top diamond, and red errors affect only the bottom diamond.

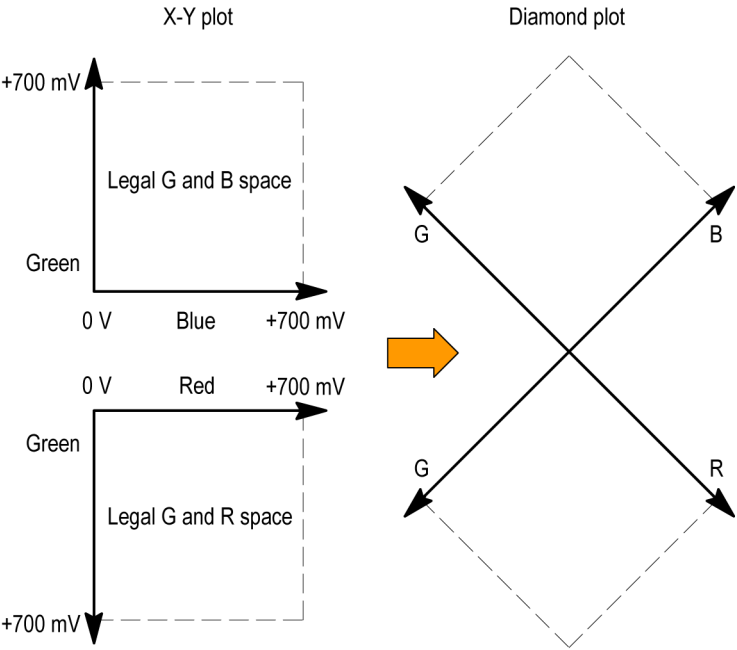

1890-030

To use the Diamond display to check RGB Gamut:

1. Perform the Setting up for Gamut Check procedure, selecting Diamond in step 6.
2. Compare the signal to the display to determine out of gamut components, noting the following:

- The intensity of a vector indicates its duration.
- A momentary out-of-gamut condition appears as a faint trace. Long duration violations show as a bright trace.

See the following step for some sample out-of-gamut signals.

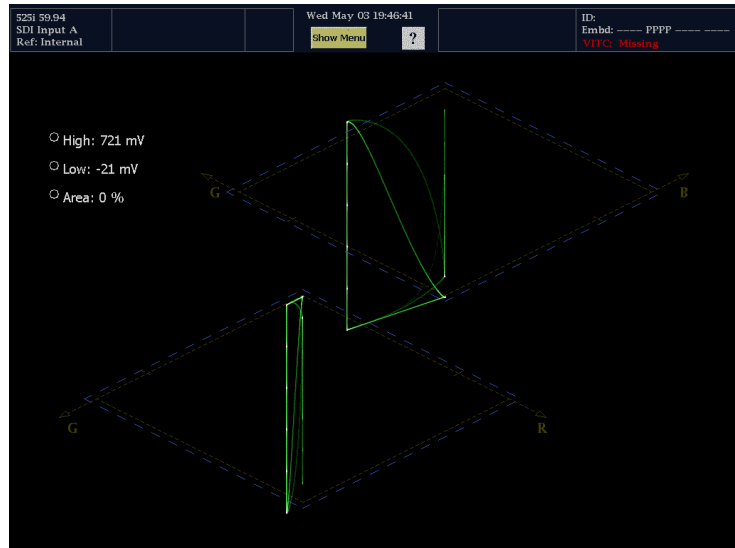

3. Consider the following examples when evaluating the signal for out of gamut components:

Example A:
 R - OK
 G > 700 mV
 B - OK

Example B:
 R - OK
 G - OK
 B > 700 mV

Example C:
 R - OK
 G - OK, 350 mV
 B < 0 mV

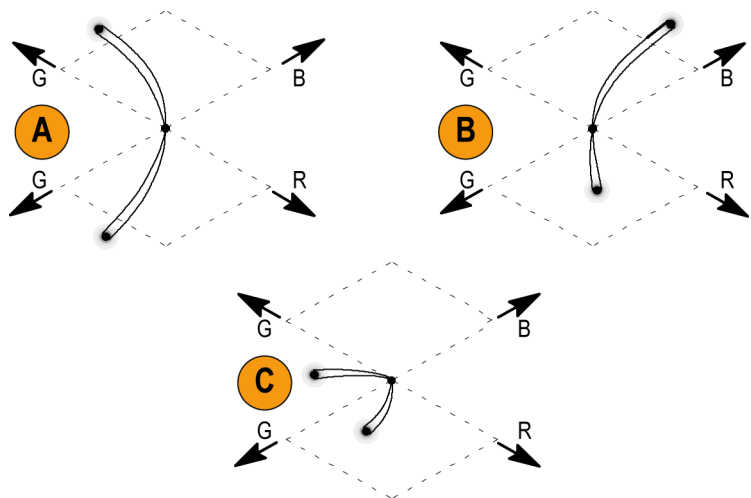

1890-031

Usage Notes

On the Diamond display, monochrome signals appear as vertical lines. Nonlinear component processing, such as from a gamma corrector that alters white balance, can cause deviations along the vertical axis. For example, the signal from a camera shooting a monochrome chip chart should appear on the Diamond display as a straight, vertical line; if it is not, then the camera is not balanced.

To isolate gamut brightups, try the following:

- Use LINE SEL mode to select individual lines.
- Use the PICTURE display to examine the monitor signal with brightups
- Use the Area % setting to specify a percentage of the screen for which to ignore for gamut violations.

Checking Composite Gamut

The Arrowhead gamut display plots luminance (Y) against chrominance (C) to check if the composite signal adheres to standard gamut. NTSC and PAL Arrowhead displays (75% Color bars) and indicates the values of the graticule lines. The arrowhead shape of the graticule results from overlaying the standard limits for luminance and luminance plus peak chrominance.

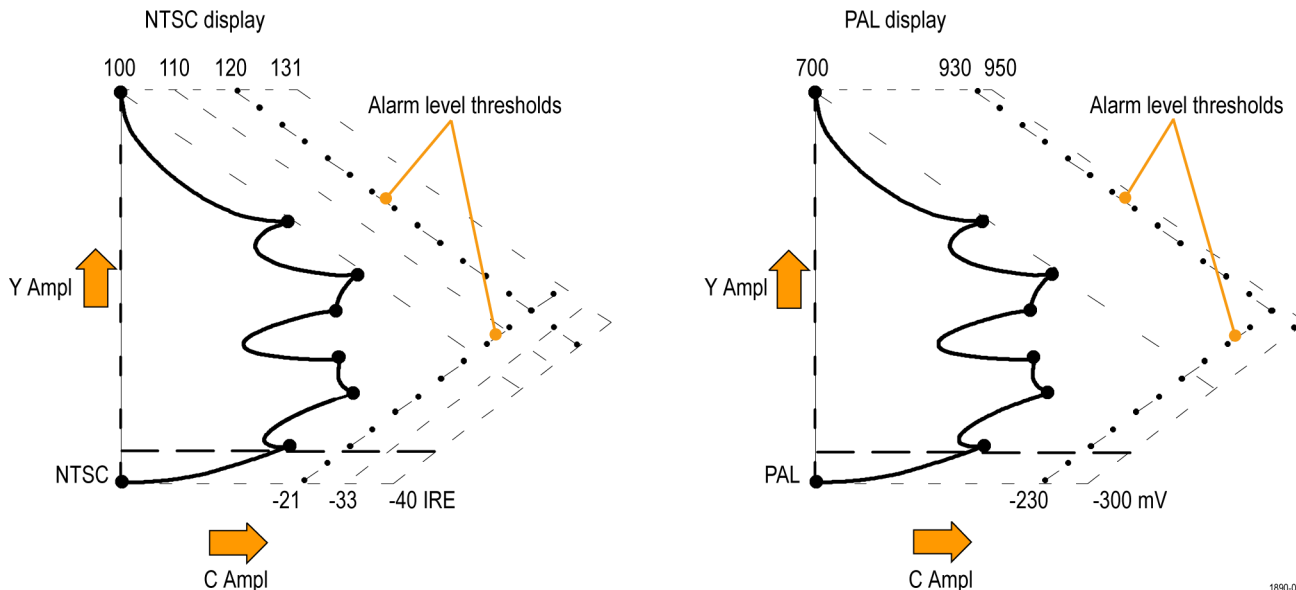

1890-032

1. Perform the *Setting up for Gamut Checks* procedure. (See page 105, *Setting up for Gamut Checks*.)
2. Compare the signal to the display to determine out of gamut composite components, noting the following:
 - Signals exceeding the luminance amplitude gamut extend above the top horizontal limit (top electronic graticule line).
 - Signals exceeding the luminance plus or minus peak chrominance amplitude gamut extend beyond the upper and lower diagonal limits.
 - The bottom horizontal line shows the minimum allowed luminance level of 7.5 IRE for NTSC and 0 mV for PAL.

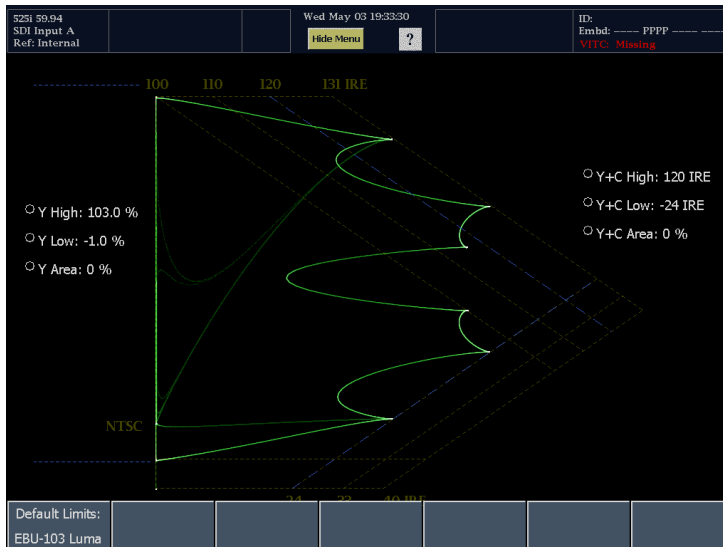

Usage Notes

- Adjusting the threshold level limits: (See page 112, *Adjusting Gamut Limits.*)
- To automate this check: (See page 111, *Automating Gamut Checks.*) Then enable alarms in Main > Config > Alarm Setup.

Checking Luma Gamut

Luma limit thresholds can be configured for identifying luma exceeding threshold limits. They apply to both the incoming SDI and to the arrowhead representation of the SDI input as a composite signal.

The thresholds are affected by your choice of set-up or no set-up for the Arrowhead display.

1. Perform the *Setting up for Gamut Checks* procedure. (See page 105, *Setting up for Gamut Checks.*) Select Arrowhead as the display.
2. Compare the signal to display to determine out of gamut luminance. Note the following:
 - The adjustable thresholds are indicated by the dark blue horizontal graticule lines.
 - The thresholds are defined in terms of percent of full scale.
 - The range for the Upper limit is 90% to 108%.
 - The range to the Lower Limit is -6% to +5%.

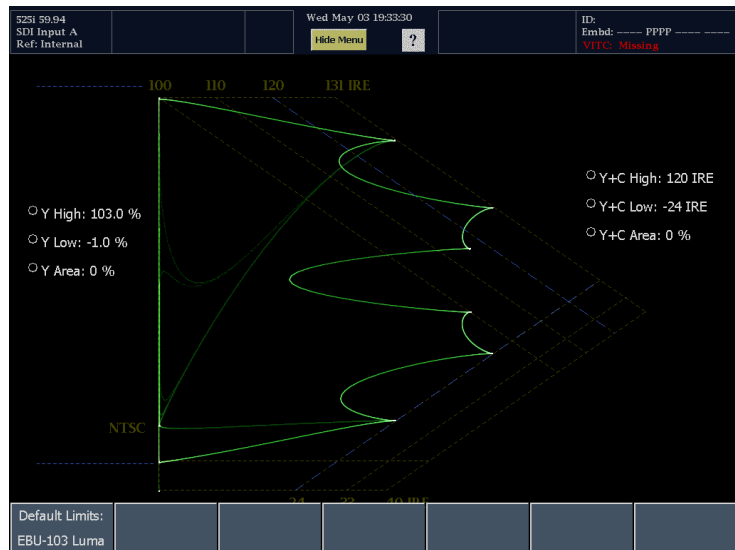

Another useful Arrowhead function is a measure of how well the active video signal is using the dynamic range of the video channel. A properly adjusted signal should be centered in the arrowhead graticule and have transitions that approach all the limits (this won't be true of dark scenes or scenes with low color content).

Automating Gamut Checks

You can use alarms to automatically monitor for out of gamut conditions:

1. Press MAIN to display the Main menu.
2. Touch CONFIG to display the Configuration menu.

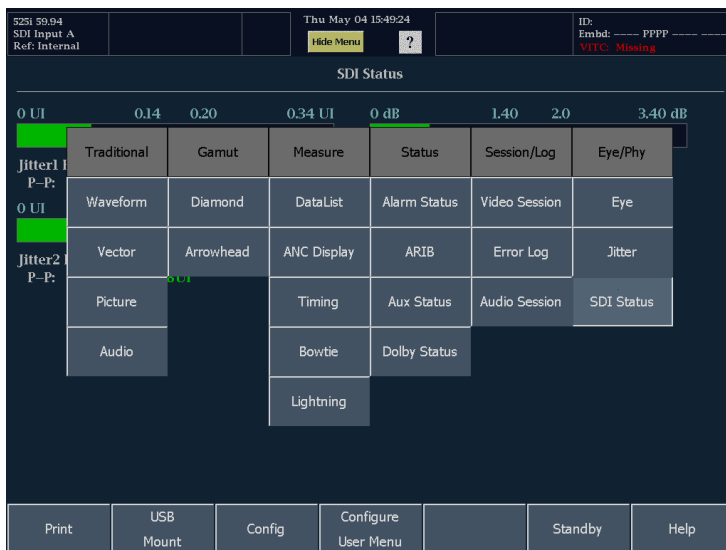

3. Touch **Alarm Setup** to display the alarm setup display.
4. On the alarm setup display, touch **Video Content**.

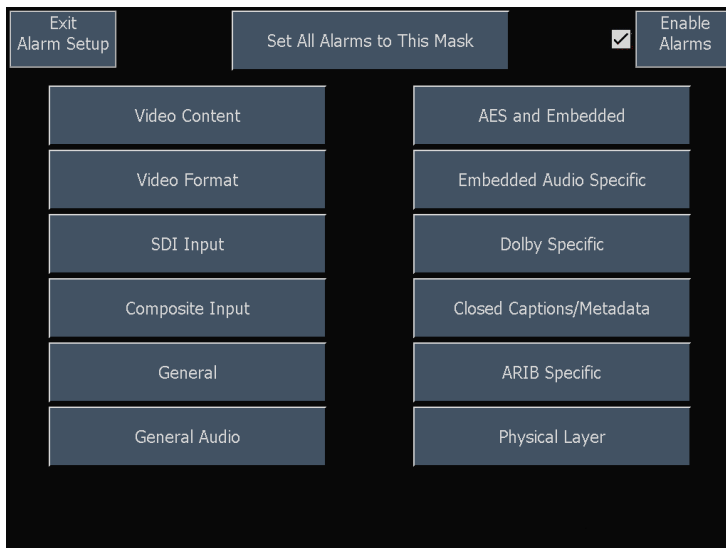

5. Select each alarm that you want to be checked.

6. Touch Save and Close to save your configuration.

VIDEO CONTENT	Txt/Icon	Log	Beep	SNMP	GC
RGB Gamut	<input checked="" type="checkbox"/>	<input checked="" type="checkbox"/>	<input type="checkbox"/>	<input type="checkbox"/>	<input type="checkbox"/>
Composite Gamut	<input checked="" type="checkbox"/>	<input checked="" type="checkbox"/>	<input type="checkbox"/>	<input type="checkbox"/>	<input type="checkbox"/>
Luma Gamut	<input checked="" type="checkbox"/>	<input checked="" type="checkbox"/>	<input type="checkbox"/>	<input type="checkbox"/>	<input type="checkbox"/>

7. Check that Enable Alarms is set to On in the Alarms menu before leaving the Alarms menu.

NOTE. For information on Alarms, press the ? icon while the CONFIG menu is displayed and then select Alarm Setup.

8. Touch **Exit Alarm Setup** to exit the Alarm Setup menu.

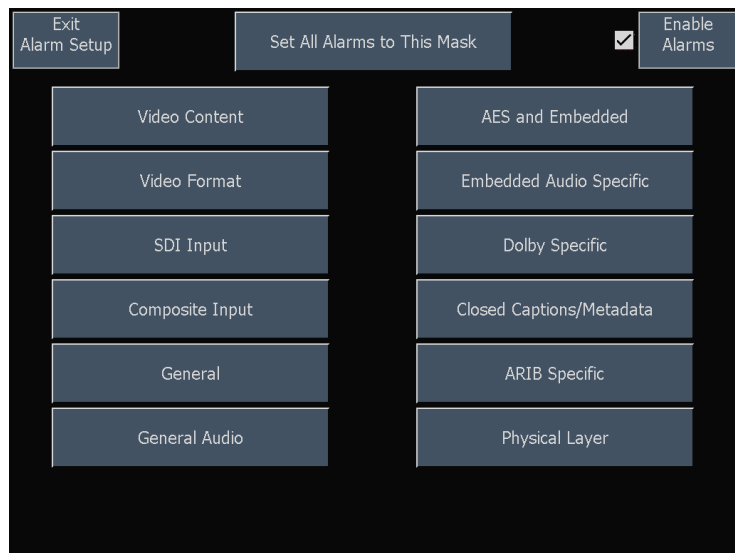

Adjusting Gamut Limits

1. Press the MAIN button to display the Main menu.

2. Select the Gamut display whose limits you want to set (either Diamond or Arrowhead). You can also reset thresholds to defaults.

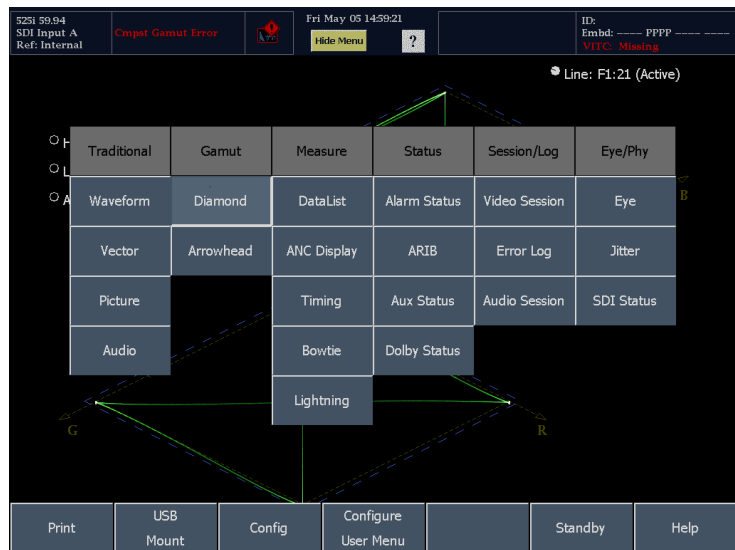

3. With either Diamond or Arrowhead displayed, touch the readout in the display for the limit you want to adjust.
4. Use the large knob to adjust the limit value.

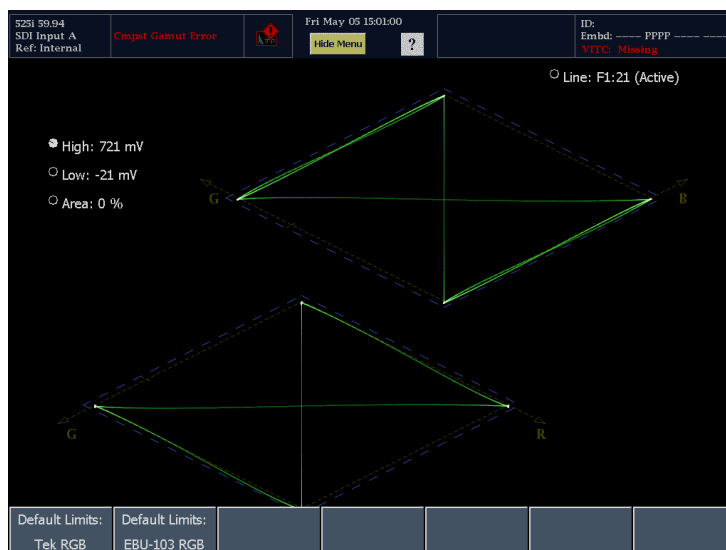

Selecting and Monitoring Audio

The waveform monitor provides several methods to monitor audio signals. You can measure levels, monitor phase, and display phase correlation. You can specify meter ballistics and scales, set the Test and Peak Program indicator levels, and specify how phase is displayed.

NOTE. With audio option DA, the waveform monitor can monitor AES, analog and Embedded audio; Option DG can only monitor AES and embedded audio.

Selecting the Audio Input

You select the audio input to be monitored from the front-panel AUDIO button pop-up menu.

NOTE. The Audio display can appear in only one tile at a time.

To select the audio input to monitor:

1. Select a tile.
2. Press the AUDIO button to open the Audio display.

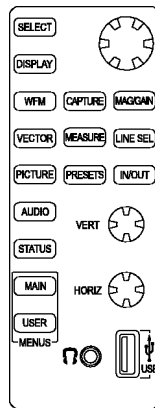

3. Select **Audio Input**, and then select one of the audio input options shown.

NOTE. The available selections depend on the installed audio option. Selecting Follows Video selects the Video to audio mapping set in the Video to Audio Map submenu.

The screenshot displays an audio monitoring interface. At the top, it shows 'NTSC', 'Cmpst Input A', 'Ref: Internal', 'Fri May 05 15:05:58', and 'ID: Audio Input: AES A'. Below this, there are two main sections: 'True Peak' and 'Linear C'. The 'True Peak' section shows two vertical bars with levels around -10 dBFS and -20 dBFS. The 'Linear C' section shows a diagram with 'L', 'C', and 'R' channels and a scale from -50 to 50. At the bottom, there is a settings menu with the following options:

Close Input	Follows Video	AES A	AES B	Embedded	Analog A	Analog B
Dolby 1	Dolby 2	Dolby 3	Dolby 4	1,2		
Audio Settings	Aux Display [Surround]	Phase Pair [Bars 1 & 2]	<input checked="" type="checkbox"/> Dominance Ind. On	Surround Filter [Linear]	Audio Input [AES A]	

Checking Audio Level & Phase

The Audio display level meters are vertical bar graphs where the height of the bar indicates the amplitude of the audio program in the corresponding input channel. You can change the input and turn on and off the Phase display from the audio pop-up menu. Other meter characteristics such as ballistics, scale units, and program/test levels are configured through the Audio Settings menu.

The waveform monitor, with optional audio, can display phase of one input pair with a Lissajous pattern display, and it can display relative phase of all four pairs of inputs with correlation meters. It can also display a representation of the surround sound field.

Check Audio Level

1. Select a tile.
2. Press the AUDIO button to open the Audio display.
3. Check the level meter bars for current audio levels, which are displayed according to the selected meter ballistics. Each bar displays three colors:
 - Green - Indicates portions of the level meters below the test level.
 - Yellow - Indicates portions of the level meters between the test and peak program level.
 - Red - Indicates portions of the level meters above the peak program level.



Check Audio Phase

1. Select **Aux Display**.
2. From the Aux Display submenu, select **Phase**.
3. Touch **Phase Style** and choose **Soundstage** or **X-Y** orientation for the Lissajous signal.
4. Touch **Phase Pair** and select the Phase Pair to be displayed.
5. Set the Audio Input to match the signal that you are checking.

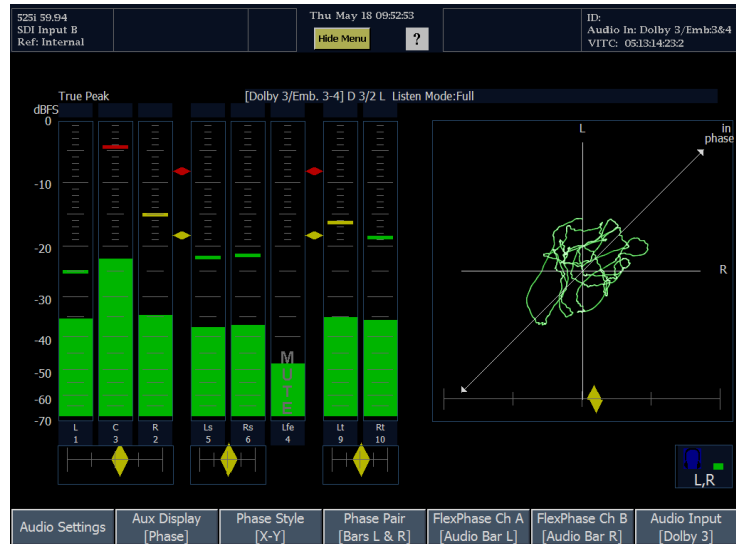

6. Check for Phase correlation of the signals, noting the following:
 - Phase correlation meters are located under the appropriate bars and one is duplicated under the phase display.
 - For correlated signals, the diamond will be green, and it will move to the right side.
 - For uncorrelated signals, the indicator will be yellow and tend to stay in the middle.
 - For anticorrelated signals (one goes up when the other goes down), the indicator will be red and will move to the left side.

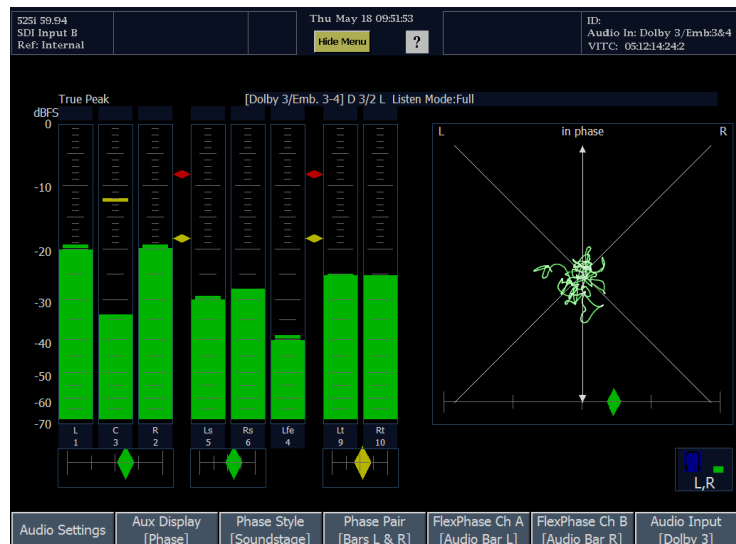

Usage Notes

- The phase, or Lissajous, display is a plot of one channel against another on an orthogonal pair of axes.
- Soundstage plots the two channels at 45 degree angles, with the mono combination appearing on the vertical axis—more like a left-right image in a studio.
- X-Y plots left-channel data on the vertical axis and right channel data on the horizontal axis, emulating the X-Y display of an oscilloscope.
- The response time of the correlation meters can be set from the CONFIG menu. The choices follow:

Speed setting	Response averaging time (s)
1	0.04
2	0.04
3	0.08
4	0.12
5	0.28
6	0.52
7	1.0
8 (default)	1.5
9	2.0
10	2.5
11	3.0
12	3.5
13	4.0
14	4.5
15	5.0
16	5.5
17	6.0
18	6.5
19	7.0
20	7.5

Checking Surround Sound

The Audio display can also display the surround sound listening environment.

To Check Surround Sound

1. Select a tile.
2. Press the **AUDIO** button to open the Audio display.
3. Touch **Aux Display**, and then touch **Surround**.
4. Set the Audio Input to match the signal that you are checking.



5. Select the **Dominance Ind. On** checkbox to display the Dominance Indicator or not as desired.
6. Touch the **Surround Filter** soft key to set the Loudness Filter type preferred. A-Weighed biases the response towards that of human hearing.
7. Use the level bar display to monitor level control.

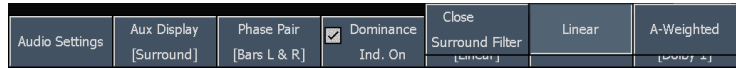

8. Use the surround display to monitor relative loudness of the individual elements rendered in a surround-sound listening environment. Check the surround sound display for performance parameters and indicators shown right. The indicators are described under usage notes below.

NOTE. The Audio Surround Sound display is courtesy of Radio-Technische Werkstaetten GmbH & Co. KG (RTW) of Cologne, Germany.

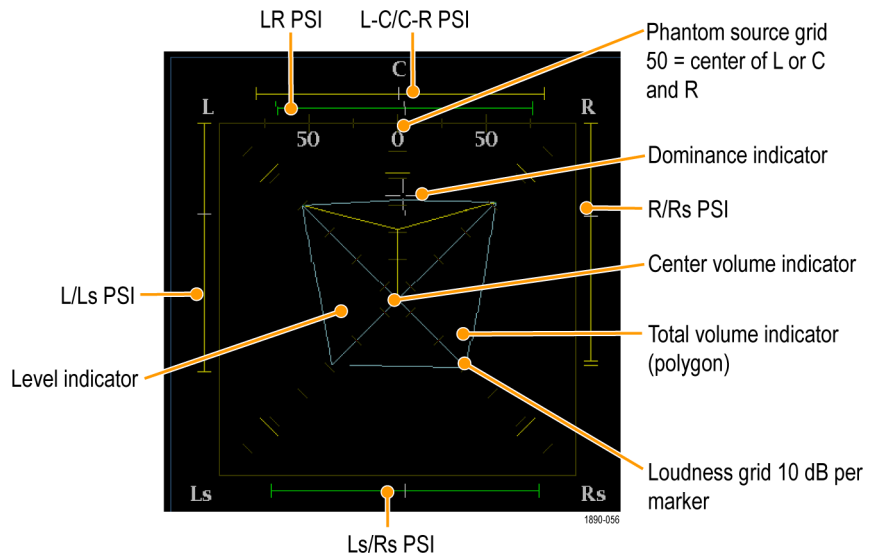

Surround Display Elements

- The Level Indicators-indicates the audio level balance among the left (L), right (R), left-surround (Ls), and right-surround (Rs) channels as cyan lines on the Loudness Grid.
- The Loudness Grid-the ruled scale, radiating from the center, on which the level indicators register their audio level and balance. The scale has tic marks at 10 dB intervals. An additional tic mark indicates the -18 dB level. The -18 dB and -20 dB levels are typically used for aligning audio levels.
- Total Volume Indicator-the cyan polygon formed by connecting the level indicator end points, showing the total sound volume of the L, R, Ls, and Rs channels. Each connecting line will bend away from the center if the two signals have a positive correlation, will bend towards the center if the signals have a negative correlation, and will not bend if the signals are uncorrelated.
- The Center Volume indicator-displays the sound volume of the center channel as a vertical yellow bar between the L and R channels, and connects the ends of the L, C, and R audio level indicators with straight lines.
- Channel-Pair Phantom Sound Indicators (PSIs-located on each side of the Surround Sound display, indicate the location of potential phantom sound sources formed by adjacent channels. The white tic marks on these moving bar indicators show the phantom source locations. The bar length indicates the correlation between the adjacent channels. A short-to-medium length green bar indicates positive correlation between the channels, forming a localized phantom sound source located at the white tic mark. The bar grows to full length and changes color to yellow as the correlation moves to zero, indicating a wide, non-localized sound image. The bar changes color to red for adjacent channels with significant negative correlation. For negative correlations, the ends of the PSI for the L and R channels will continue to grow at a 45° angle while the other PSIs remain at full length.
- Center-Pairs Phantom Sound Indicator-a fifth PSI at the top of the display shows potential phantom sources formed by the LC channel pair and the CR channel pair. If the L, R, and C channels all have the same signal level, the white tic mark on the bar will appear directly above the C level indicator. The white tic mark will move right or left depending on the relative balance between the three channels. A short bar to the left of the white tic mark indicates a positive correlation between L and C. The bar will grow as the correlation decreases. Like the L-R PSI, the bar will continue to grow at a 45° angle for negative signal correlations. The bar to the right of the white tic mark behaves in the same way, depending on the C-R correlation. This PSI indicator uses the same color coding as the other PSI indicators.

Usage Notes

The following displays are examples of how the surround sound waveform appears for some typical signal types.

1. Uncorrelated signals; same level in the L, C, R, Ls, and Rs channels.

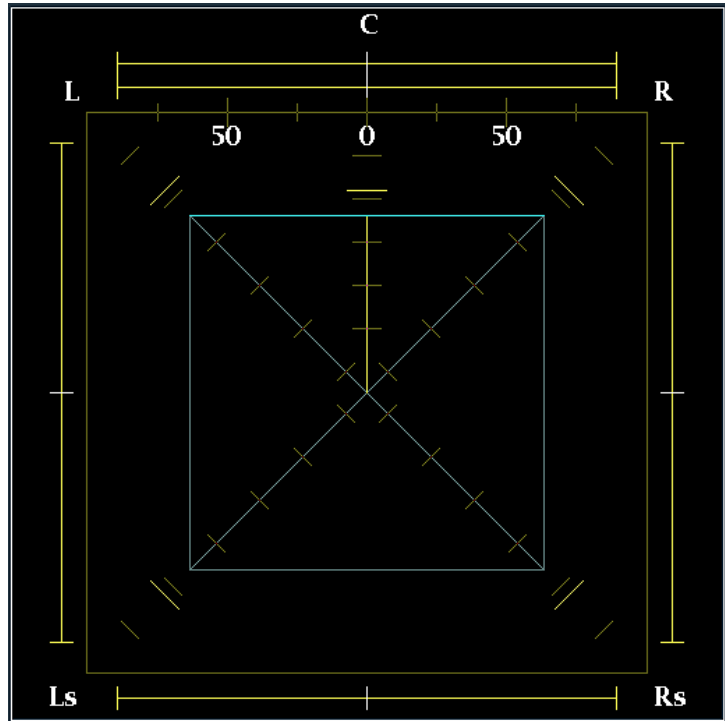

2. Sine wave test tone; same level in the L, C, R, Ls, and Rs channels. All signals are in phase, creating phantom sources between the adjacent channels.

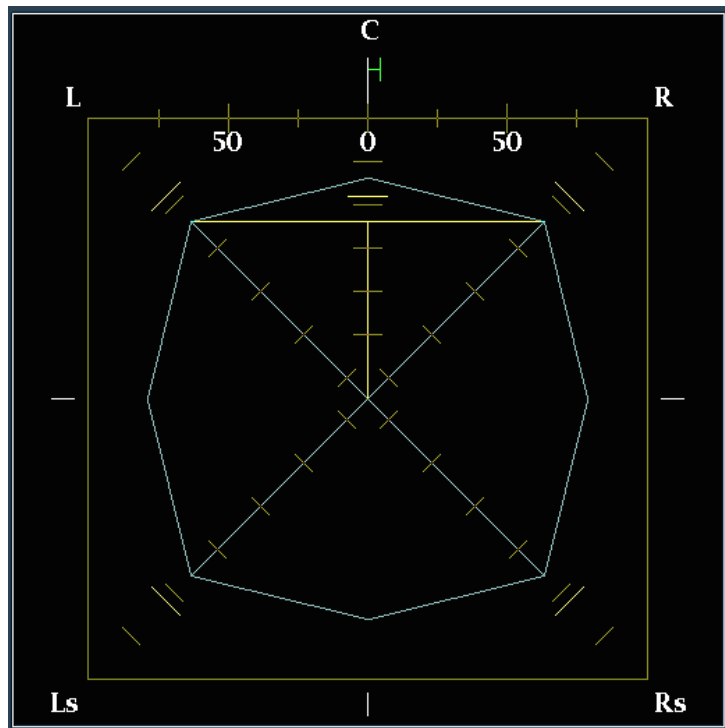

- 3. Same as 2, with the exception that Channel L is out of phase.

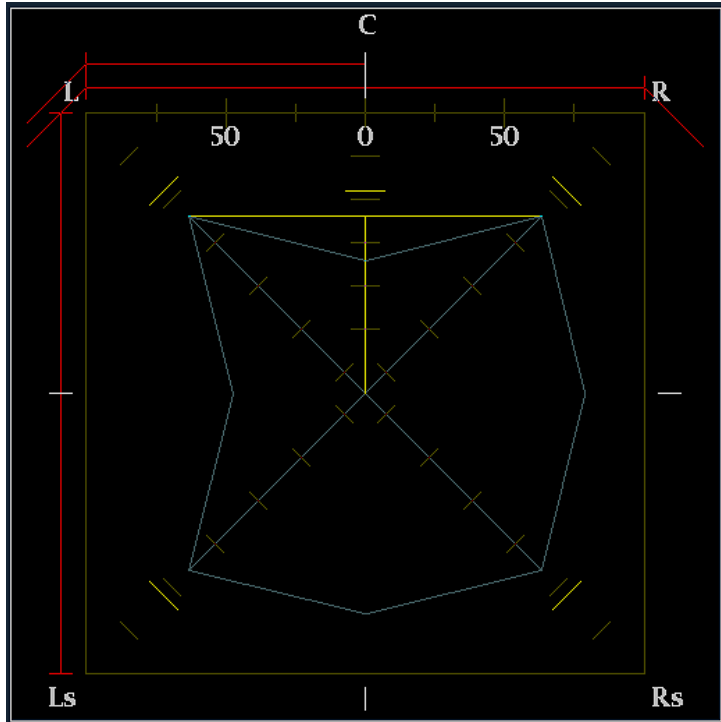

- 4. Surround sound program with strong center channel presence. Note that the center bar is above the left and right levels. This indicates that the center level is greater and will be more audible than the ambient sound.

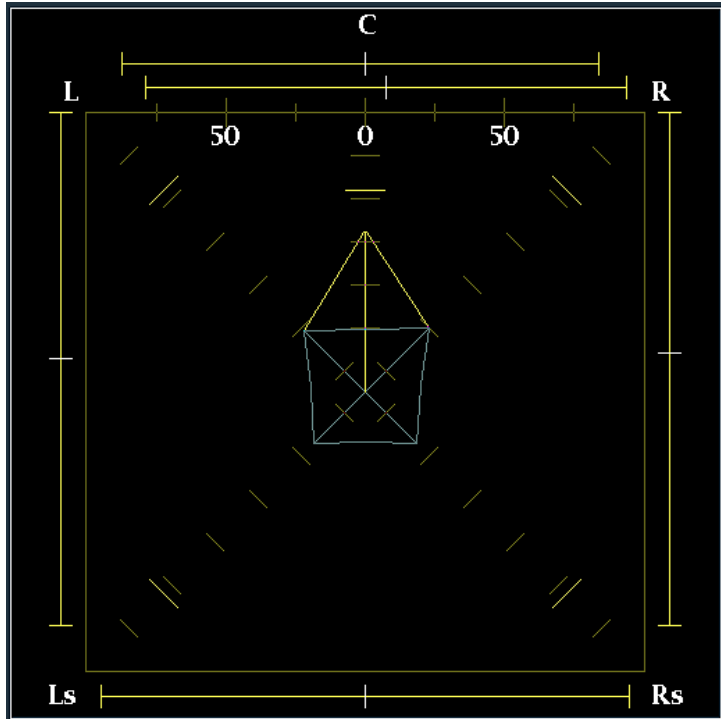

5. Surround sound program with weak center channel presence. Note that the center bar is below the left and right levels. This indicates that the center level is weaker and will be less audible than the ambient sound.

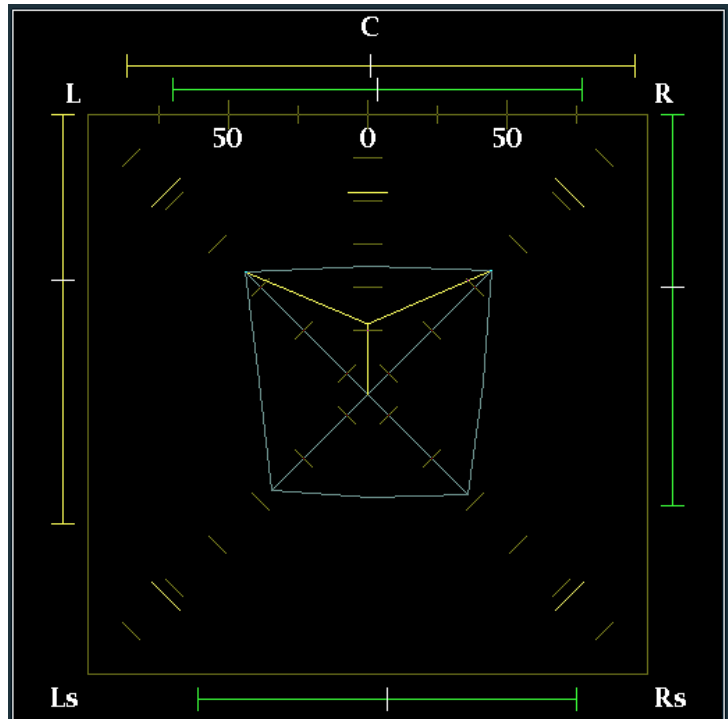

6. Monaural signal in channels Ls and Rs, creating a phantom source in the center, as in a 3.1 surround sound system.

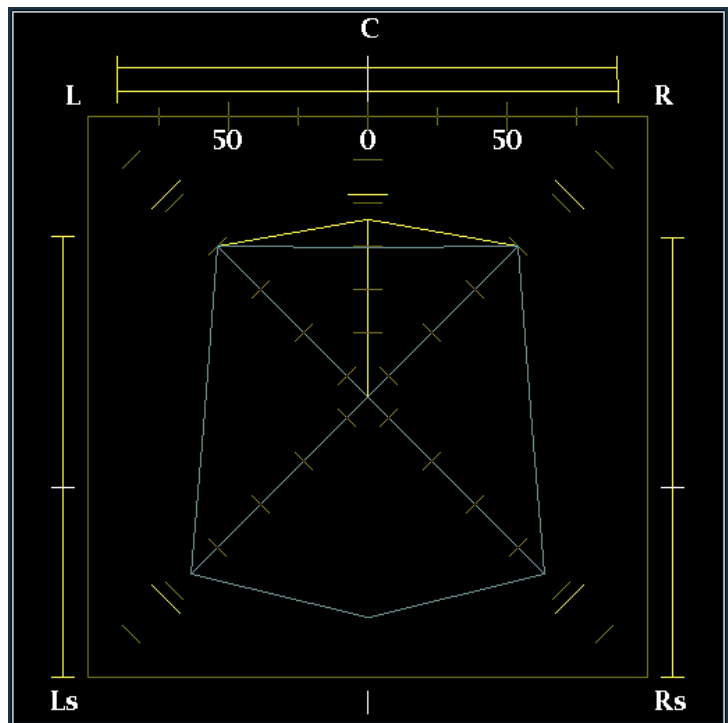

Remote Communications

Remote communications that are covered here include those that are:

- Over an Ethernet network through a Web browser.
- Over an Ethernet network through a Java applet.

Using the Remote Web Interface

You can connect to the waveform monitor and perform simple operations without installing any software and using just a Web browser. To use a Web browser to connect to a waveform monitor, the waveform monitor must be connected to an IP network via Ethernet. You will need to set the IP Config Mode, IP Address, Subnet Mask, and possibly the Gateway Address depending on your network configuration.

Using only a Web browser, you can save screen captures, download the error log, download the diagnostics log, and view the instrument options. To connect to the waveform monitor using a Web browser:

1. Set up the waveform monitor to connect to a network (if you have not already done so. (See page 51, *To Connect to a Network*.)
2. Start your Web browser and type the network address of the waveform monitor into the URL entry box like this:
http://123.123.123.123

NOTE. Many Web browsers do not correctly interpret IP addresses with leading zeros. If the IP address shown in the Configuration menu contains leading zeros as in 124.161.038.151, remove the "0" when entering it into the address line of the browser. For example, 124.161.038.151 should be entered as 124.161.38.151.

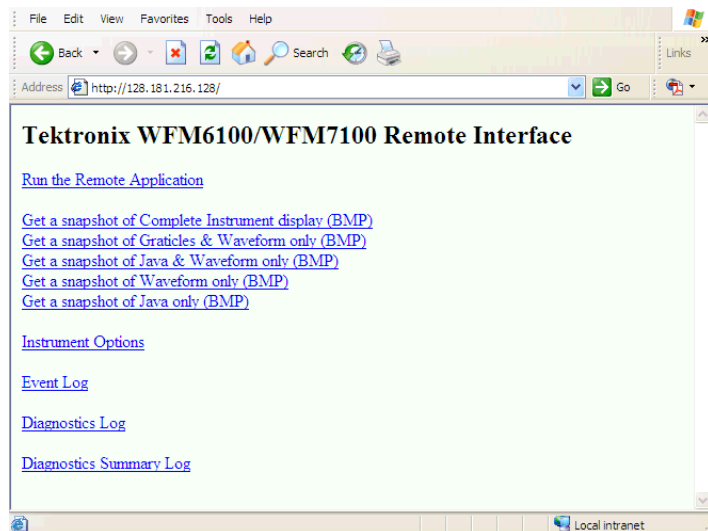

Do any of the following steps as desired:

3. Click **Run the Remote Application** to start the Java applet (see next procedure).
4. Click one of the **Get a snapshot** links to download a bitmap image.
5. Click **Instrument Options** to display which options the instrument is equipped with.
6. Click **Event Log** to display the Error Log as an HTML table.
7. Click **Diagnostic Log** to display the diagnostics log as an HTML table.
8. Click **Diagnostics Summary Log** to display a brief summary of the diagnostics log as an HTML table.

[Run the Remote Application](#)

[Get a snapshot of Complete Instrument display \(BMP\)](#)

[Get a snapshot of Graticles & Waveform only \(BMP\)](#)

[Get a snapshot of Java & Waveform only \(BMP\)](#)

[Get a snapshot of Waveform only \(BMP\)](#)

[Get a snapshot of Java only \(BMP\)](#)

[Instrument Options](#)

[Event Log](#)

[Diagnostics Log](#)

[Diagnostics Summary Log](#)

Using the Remote Application

To further extend your control from a remote PC, launch the Remote Application from the Web browser. The Remote Application reproduces the display and front panel of the waveform monitor on your PC display. Running the Remote Application gives you a virtual front panel that gives you complete remote control over the instrument.

Note that the Web interface operation is optimized for screen resolutions of 1024 x 768 or higher. Operation on computers with lower resolution requires scroll-bar use to see the entire interface.

Remote Application Requirements

If you install Java on your PC, you can launch a Java applet to control the waveform monitor. The Java Applet requires:

- Version 1.41 (or later) of the Java Run-Time Environment (JRE) from Sun Microsystems installed on your PC. To download the JRE (Java Run-Time Environment) plug-in from Sun Microsystems, download the appropriate code from the URL: <http://java.sun.com/j2se/1.4/>

Once you download the executable file, launch the installation software and follow the instructions.

- Microsoft Internet Explorer 5.0 or later running on a Windows PC.
- Netscape on Apple, Linux or UNIX machines.

Launching the Remote Application

When you launch the Remote Application, it is downloaded from the waveform monitor and launched. There is no software installation required to use the applet (other than the Java Run-Time Environment noted previously).

1. Launch the Web browser. (See page 124, *Using the Remote Web Interface*.)
2. Once the Remote Interface appears, select **Run the Remote Application**. The Java applet will be launched.

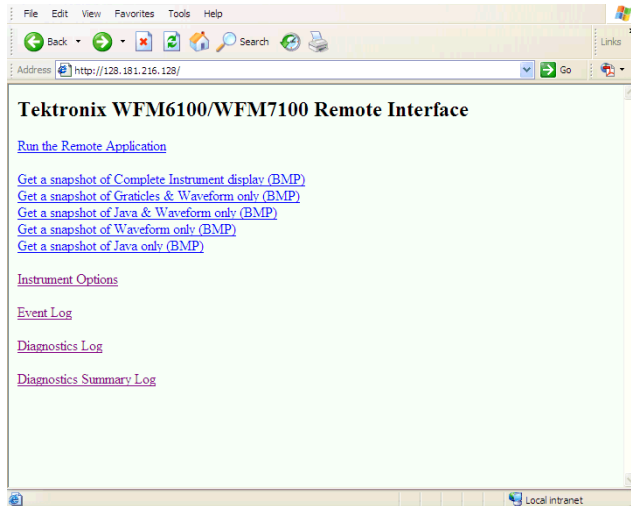

3. To control the waveform monitor, click on the buttons in the Applet Control window or click on soft keys or labels in the Applet window as though you were touching the display of the waveform monitor.
4. For front panel functions, click the virtual front-panel controls to remotely press most instrument front panel controls.

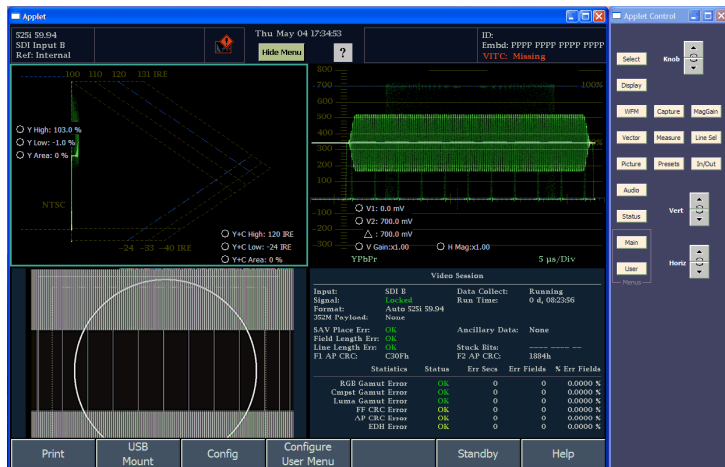

Operating Notes

- When adjusting variable settings, such as vertical and horizontal position, click on the up and down arrows in the Applet Control window that represent the knobs on the waveform monitor front panel.
- To close the Remote Application, click on the close window button at the top-right corner of the Applet window.

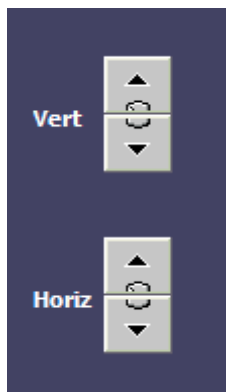

To Upgrade the Waveform Monitor Software

System Upgrade (CONFIG> Utilities > System Upgrade) is used to upgrade the system software of the waveform monitor. The upgrade is performed across an Ethernet network using a PC to transfer the new software to the waveform monitor.

PC System Requirements

The data-transfer utility for upgrading the waveform monitor runs on these PC systems: Windows 98, Windows NT 4.0, Windows ME, Windows 2000, and Windows XP.

The data-transfer utility also requires Winsock 2.0, an Ethernet interface, and 128 MB of free disk space be present on the PC system.

Before You Begin

Read the entire procedure before starting the upgrade. The time required to complete the upgrade is about 25 minutes.



CAUTION. *Once the instrument has started to erase internal flash, DO NOT remove power from the instrument. If you do so, the instrument flash will be corrupted. The instrument will have to be sent to a Tektronix factory service center to have the system software restored.*

NOTE. *If power to the instrument is lost before it begins erasing the internal flash, you can restart the software upgrade after the instrument reboots.*

Installing the Software

To install new software in a waveform monitor:

Download the software package

1. To download the latest version of the waveform monitor software, navigate to the Tektronix Web site at http://www.tek.com/products/video_test.
2. From there, follow the link *Software and Firmware* under Product Resources to locate the waveform monitor software-upgrade package and download it.

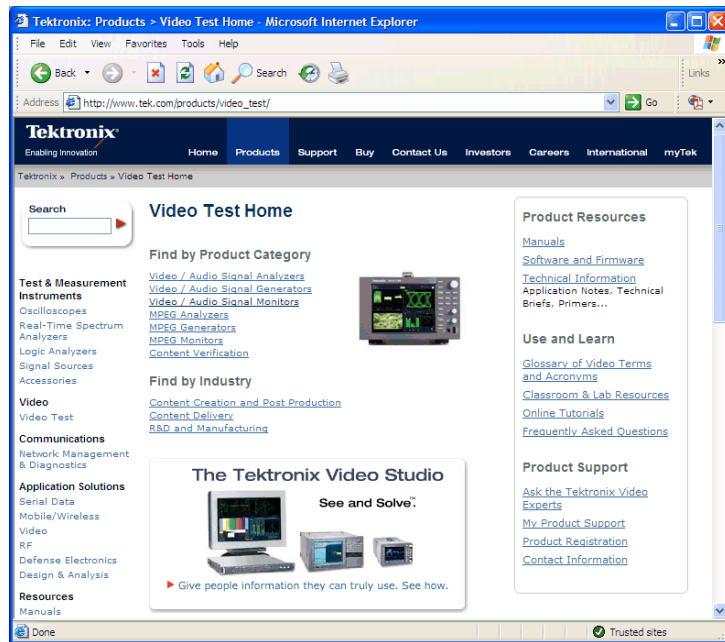

3. Click on the downloaded self-extracting archive to extract the following files into a directory of your choice. Files extracted are: *transfer.exe*, *firmware.pkg*, and *readme.txt*.

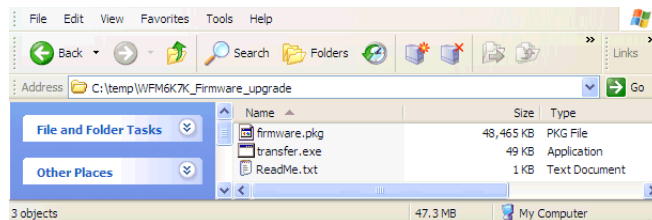

Check and Record the IP Address

4. Press **CONFIG** to display the Configuration menu.
5. Select **Utilities** to display the Utilities menu.
6. Select **Communications** to display the Communications menu.
7. Select **Network Setup** to display the network settings.
8. Write down the number listed for **IP Address** in the menu.

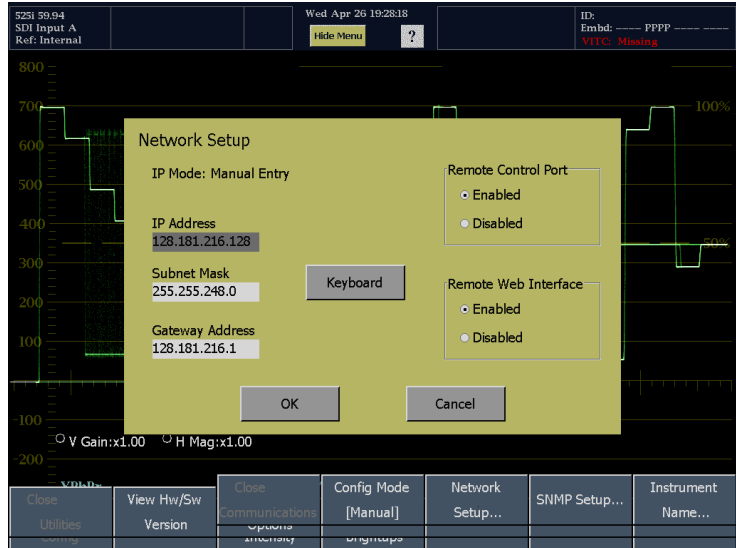

Enter System Upgrade Mode

9. On the waveform monitor, press the **MAIN** button to display the Main menu.
10. Touch **Config** to display the Configuration menu.
11. Touch **Utilities** to display the Utilities menu.
12. Touch **System Upgrade**. This displays a dialog box that requires you to confirm that you want to upgrade the system.
The waveform monitor display goes to black and will display a screen stating that it is waiting for data transfers from the network.

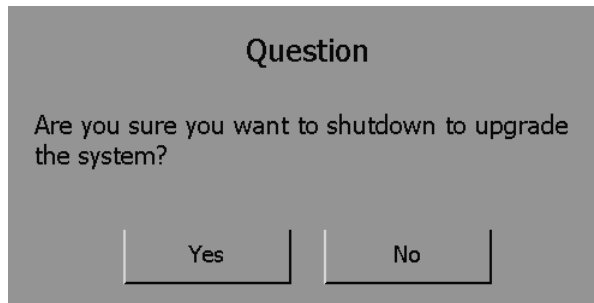

Run the Upgrade

13. On the PC, double-click the **transfer.exe** file to launch the transfer program. This displays the window shown at right.
14. Type the network address (for example: 192.168.221.2) or DNS name of the waveform monitor you want to update, and then press Enter. This starts the software upgrade process.

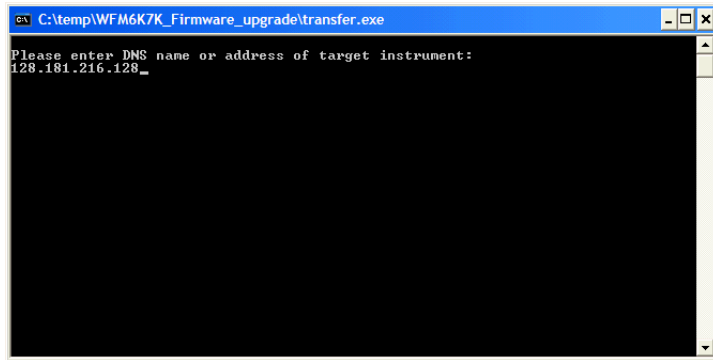

15. The transfer utility asks you to enter another IP address when the software upgrade completes.



CAUTION. Do not close the *transfer.exe* window until the transfer utility asks for another IP address.

When the software upgrade completes, the waveform monitor will reboot.

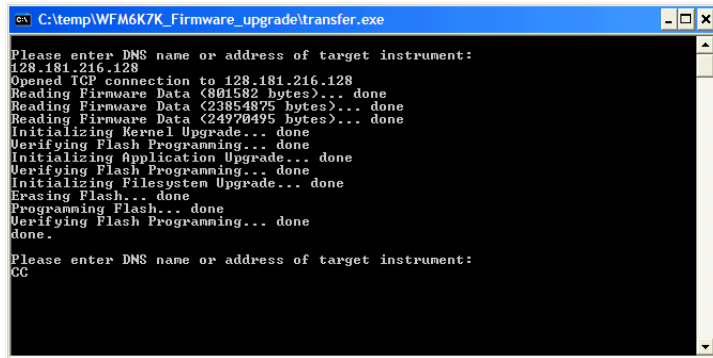

16. To update another waveform monitor, begin at step 5 and skip step 12. If you won't be updating another waveform monitor, press **Enter** to exit the transfer utility.

Verifying the Upgrade

After you have completed the software upgrade, the instrument will reboot and come up in the touchscreen calibration mode. Follow the instructions that appear on screen to complete the upgrade.

NOTE. See the *Readme.txt* file that is included with the software-upgrade package to determine whether all of the current Configuration menu and instrument-mode settings are preserved through upgrading.

To verify the software upgrade, check the software version in the View HW/SW Version display in the Config > Utilities menu.

1. Press the **MAIN** button.
2. Touch the **Config** soft key.

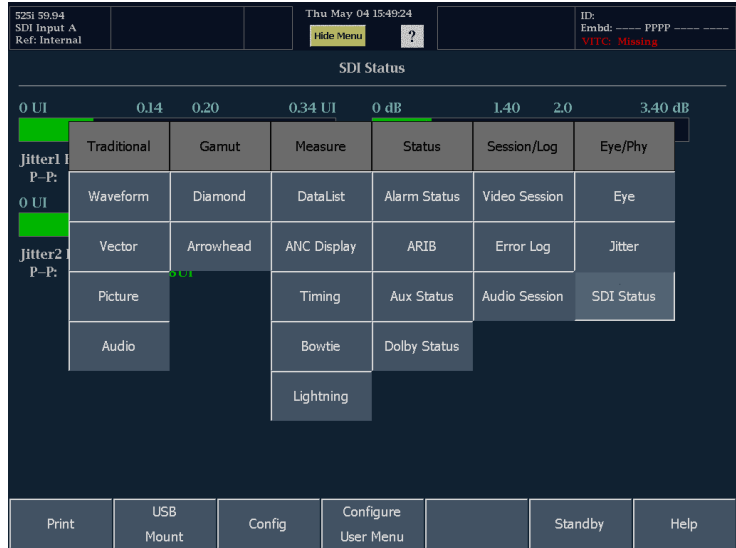

3. Touch the **Utilities** soft key.

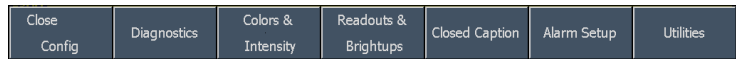

4. Touch the **Hw/Sw Version** soft key.
5. Check the software version listed under the copyright. Verify that the version number matches the version you installed.

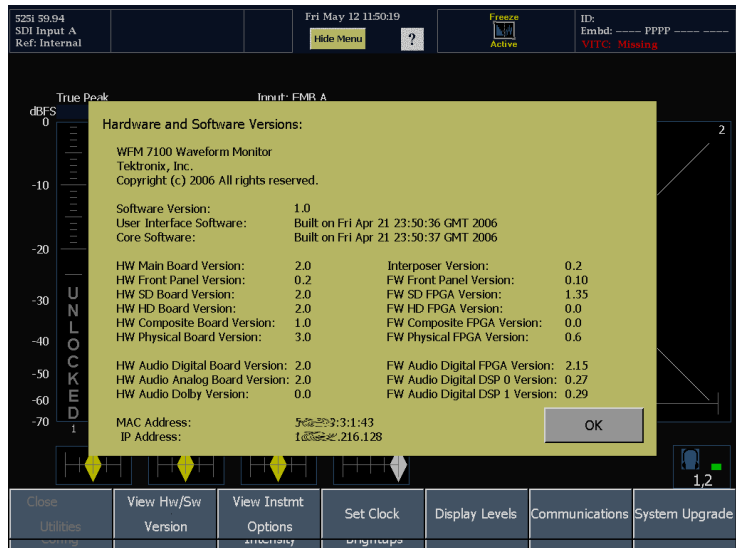

To verify the functional performance of your instrument, perform the Incoming Inspection procedure in the *WFM6100, WFM7000, and WFM7100 Waveform Monitors Specifications and Performance Verification Technical Reference* (Tektronix part number 071-1897-XX). The manual is available as a PDF file on the Documents CD and can also be downloaded from the Tektronix Web site free of charge.

Specifications

This section provides an abbreviated list of the instrument specifications.

Characteristic	Description
Input Voltage	100 to 240 VAC \pm 10%,
Input Power Frequency	50/60 Hz
Power Consumption, typical	50 to 110 VA at 110 or 240 VAC; Depends on options installed. 50 Watts typical for base unit.
Serial Digital Video Interface	
Input Type	75 Ω BNC, internally terminated.
Input Level	800 mV p-p \pm 10%
Composite Video Interface	
Maximum Operating Amplitude	-1.8 V to + 2.2 V, DC + peak AC
Absolute Maximum Input Voltage	-6.0 V to + 6.0 V, DC + peak AC
Digital Audio	
AES Input Characteristics	BNC, 75 Ω terminated, unbalanced, 0.2 V to 2 V p-p
Temperature	
Operating	0 °C to +40 °C
Non-operating	-20 °C to +60 °C
Altitude	
Operating	3,000 meters (9,842 feet)
Non-operating	12,192 meters (40,000 feet)
Pollution Degree	2, Indoor use only.

Physical Characteristics

Dimensions	mm	in
Height	133.4	5.25
Width	215.9	8.5
Depth (front to back including handles and BNCs)	460.4	18.125
Weight	kg	lbs
Net	5.5	12
Shipping	9.1	20

Index

Symbols and Numbers

- 1 Field
 - Sweep submenu, 62
 - 1 Line
 - Sweep submenu, 62
 - 2 Field
 - Sweep submenu, 62
 - 2 Line
 - Sweep submenu, 62
- ## A
- Accessories
 - documents, 1
 - Optional, 1
 - power cords, 1
 - standard, 1, 4
 - Active Picture
 - Picture Settings, 65
 - Active tile, 11
 - AES connectors, 20
 - Alarm Setup soft key
 - Config menu, 48
 - Alarm Status
 - Main menu, 78
 - Analog audio
 - connecting, 22
 - Analog Input/Output connector, 20
 - ANC Data
 - display, 77
 - Ancillary Data Present
 - Aux Status display, 79
 - Applications
 - Checking Chroma/Luma delay, 102
 - Checking Gamut, 105
 - Monitoring Audio, 114
 - Monitoring SDI Physical Layer, 86
 - Remote communications, 124
 - Timing a studio, 97
 - ARIB status
 - Main menu, 78
 - Arrowhead
 - composite gamut, 109
 - display, 71
 - display, elements of, 71
 - menu, 72

- Arrowhead display, 105
- Audio
 - AUDIO button, 65
 - display elements, 65
 - menu, 68
- AUDIO button, 12
- audio input
 - selecting, 114
- Audio Input
 - Audio menu, 68
- audio level
 - checking, 116
- audio phase
 - checking, 116
- Audio Session
 - Main menu, 82
- Aux Display
 - Audio menu, 68

B

- Bar Targets
 - Vector menu, 64
- Basic operation, 7
- Bowtie
 - display, 75
- brightups, 105

C

- Cable Loss
 - thermometer, 85
- Capture
 - Buffer, 40, 42
 - clearing, 43
 - copying to a flash drive, 44
 - restoring from a flash drive, 45
 - Trace, 40, 42
 - triggering, 42
 - Using the capture display, 40
- CAPTURE button, 12
- Capture Display On
 - Capture menu, 41
- CC 608 Service
 - Picture menu, 65
- CC Services
 - Aux Status display, 79

- Chroma
 - Components submenu, 62
- Chroma/Luma delay, 102
- Clear
 - Capture buffer, 43
- Close Caption soft key
 - Config menu, 48
- Closed Caption Type
 - Aux Status display, 79
- Color Space
 - RGB, 62
 - SDI -> Composite, 62
 - YPbPr, 62
 - YRGB, 62
- Colors & Intensity soft key
 - Config menu, 48
- Compass Rose On
 - Vector menu, 64
- Component/Composite
 - Vector menu, 64
- Components
 - Waveform menu, 62
- Components submenu
 - Chroma, 62
 - Flat, 62
 - Luma, 62
- Composite gamut
 - Diamond display, 109
- Composite Input connectors, 18
- Config menu, 48
- Connecting AC power, 4
- Connecting signals
 - Line termination, 6
- Connector
 - Compatibility, 6
- Connector(s)
 - AES, 20
 - Analog Input/Output, 20
 - Ethernet, 24
 - Pix, 23
 - Power, 17
 - Remote, 23
 - Video input, 18
 - XGA, 22
- Cursors
 - Displaying, 39
 - How to use, 39

D

- DataList
 - display, 76
 - display colors, 76
- Default Limits: EBU-103 RGB
 - Arrowhead menu, 72
 - Diamond menu, 70
- Default Limits: Tek RGB
 - Diamond menu, 70
- Diagnostics soft key
 - Config menu, 48
- Diamond
 - menu, 70
- Diamond display, 70, 105
 - checking RGB Gamut, 107
 - construction of the diamond
 - graticule, 107
 - RGB gamut, 107
- Display
 - ANC Data, 77
 - Arrowhead, 71
 - Bowtie, 75
 - changing views, 11
 - DataList, 76
 - Diamond, 70
 - Eye, 82
 - Jitter, 84
 - Lightning, 69
 - resolution, 22
 - Status, 78
 - Timing, 72
- DISPLAY button, 12
- Display connector *See* XGA Output connector
- Documentation
 - conventions used in, viii
 - purposes of, viii
- Dolby Status
 - Main menu, 79

E

- Error Log
 - Main menu, 81
- Ethernet connector, 24
- Eye
 - display, 82

F

- Factory defaults
 - recalling, 34

Features

- List of key, vi
- Filter
 - Waveform menu, 62
- Flat
 - Components submenu, 62
 - Waveform menu, 62
- FlexPhase
 - Audio menu, 69
- FlexVu, 11
- Follows video
 - Audio menu, 68
- front panel
 - connectors, 13
 - controls, 12
- Full frame
 - Picture Settings, 65

G

- Gain
 - How to set, 28
- Gamut
 - Arrowhead display, 109
 - checking, 105
 - checking RGB gamut, 107
 - Diamond display, 107
 - display, elements of, 70
- Gamut checks
 - automating, 111
- Ground closure connector, 23

H

- Headphone volume
 - adjusting, 47
- HORIZ knob, 13
- Horizontal Offset
 - Timing display, 72

How to...

- capture the display, 40
- configure your instrument, 48
- connect to a network, 51, 54
- create a User menu, 58
- measure waveforms with
 - cursors, 39
- operate your waveform
 - monitor, 7
- print, 54
- select a measurement, 25
- select an input, 26
- set gain and sweep, 28
- set line select mode, 46
- set measurement
 - parameters, 26
- set to factory default
 - settings, 30
- use online help, 49
- use presets, 30

I

- IN/OUT button, 13
- Inputs
 - How to select, 26
- Installation, 4
 - BNC connector compatibility, 6
 - Connecting power, 4
 - In a serial video system, 4
 - Line-termination
 - requirements, 6
- IP settings, 51
- IQ Axis On
 - Vector menu, 64

J

- Java applet
 - accessing remote
 - application, 125
- Jitter
 - display, 84
 - thermometer, 85

L

- large knob, 13
- Lightning
 - display, 69, 102
- limits
 - Gamut, 105
- Line / Word
 - DataList display, 76

LINE SEL button, 12
 Line Select mode
 how to set, 46
 Live Display On
 Capture menu, 41
 Luma
 Components submenu, 62
 Luma/Chroma delay, 102

M

MAG/GAIN button, 12
 MAIN button, 12
 Main menu, 10
 Manuals
 conventions used in, viii
 purposes of, viii
 Measure
 display, elements of, 72
 How to, with cursors, 39
 MEASURE button, 12
 Measurement
 How to select, 25
 How to set parameters, 26
 Menus
 Audio, 68
 Config, 48
 Main, 10
 Picture, 65
 Vector, 64
 Waveform, 62
 MyMenu
 how to create, 58

N

Network
 Connect to, 51, 54
 IP settings, 51
 SNMP settings, 51
 Normal / SCH Phase
 Vector menu, 64

O

Online help
 Displaying, 49, 50
 How to use, 49
 Operation
 Basic, 7
 Optional accessories, 1

Options, 2
 Eye, 85
 Phy, 85
 power cords, 1
 Other
 display, elements of, 69
 Overlay
 Waveform menu, 62

P

Parade
 Waveform menu, 62
 Part numbers
 manuals, 1
 Phase display, 116, 117
 Phase Pair
 Audio menu, 69
 Phase Style
 Audio menu, 68
 Phase: Normal / +V
 Vector menu, 64
 Picture
 button, 64
 display, 64
 menu, 65
 PICTURE button, 12
 Pix Mon Output connector, 23
 Power
 AC requirements, 4
 Connecting, 4
 Connector, 17
 Switch (none required), 4
 Power cord options, 1
 Power, connecting, 4
 Power-up Preset
 changing, 35, 36
 Presets
 copying from a flash drive, 32
 copying to a flash drive, 32
 using, 30
 PRESETS button, 12
 Printing
 creating a printer, 56
 how to, 54
 Product description, vi

R

Readout Format
 DataList display, 76
 Readouts & Brightups soft key
 Config menu, 48

Rear-panel
 Layout and description, 16
 Recall
 Presets, 31
 Reference signals
 supported, 18
 Rel. to Rear Offset
 Timing display, 73
 Rel. to Saved Offset
 Timing display, 73
 Relative to
 Timing display, 73
 Remote Application, 125
 Remote connector, 23
 Remote Control Port, 52
 Remote Web Interface, 52, 124
 RGB
 Color Space submenu, 62
 RGB gamut
 Diamond display, 107

S

Safe Area
 Picture menu, 65
 Safety Summary, iii
 Save
 Presets, 31
 Save Offset
 Timing display, 73
 SDI -> Composite
 Color Space submenu, 62
 SDI input connectors, 18
 SDI Status
 display, 85
 SELECT button, 12
 selecting audio input, 114
 Settings
 Picture menu, 65
 Tile, 10
 Show Instruction Dialogs soft
 key, 61
 Signal connection
 Line-termination
 requirements, 6
 SNMP settings, 51
 Software Upgrade
 procedure, 127
 Sound Stage
 Phase Style, 117
 Specifications, 133

- Standard accessories, 1
 - documents, 1
 - power cord, 1
- Status
 - display, 78
- Status bar
 - Elements of, 15
- STATUS button, 12
- Surround
 - Audio menu, 68
- Surround display, 118
 - elements of, 120
 - examples of, 121
- Surround Filter
 - Audio menu, 119
- Sweep submenu
 - 1 Field, 62
 - 1 Line, 62
 - 2 Field, 62
 - 2 Line, 62

T

- Termination
 - Requirements for, 6
- Tile
 - settings, 10
- Timing
 - Chroma/Luma delay, 102
 - display, 72, 97
 - Relative to., 73
 - Save Offset, 73
- Timing a studio
 - Router inputs, 99
 - Task description, 97
 - Timing-display method, 97
- Traces
 - DataList display, 76

- Transmission Signal Identifier
 - Aux Status display, 79
- Triggering
 - Capture, 42

U

- Upgrade
 - kits, 3
 - system software, 127
- USB port
 - speed, 13
 - supported standards, 13
- USER button, 12
- User menu
 - how to create, 58
- Utilities soft key
 - Config menu, 48

V

- V-Chip Rating
 - Aux Status display, 79
- Vector
 - display, 63, 102
 - display, elements of, 63
 - menu, 64
- VECTOR button, 12, 63
- Vector menu
 - Bar Targets, 64
- VERT knob, 13
- Vertical Offset
 - Timing display, 72
- Video / Data
 - DataList display, 76
- Video input connectors, 18
- Video Session
 - Main menu, 81

- View
 - soft keys, 11
- Views button, 11

W

- Waveform
 - Components, 62
 - display, 61
 - display, characteristics of, 64
 - Display, elements of, 61
 - Filter, 62
 - Filter: Flat, 62
 - Filter: Low Pass, 62
 - Filter: Luma, 62
 - menu, 62
 - Overlay, 62
 - Parade, 62
- web browser
 - accessing remote interface, 124
- WFM button, 12, 61

X

- X-Y
 - Phase Style, 117
- XGA Output connector, 22

Y

- YPbPr
 - Color Space submenu, 62
- YRGB
 - Color Space submenu, 62